

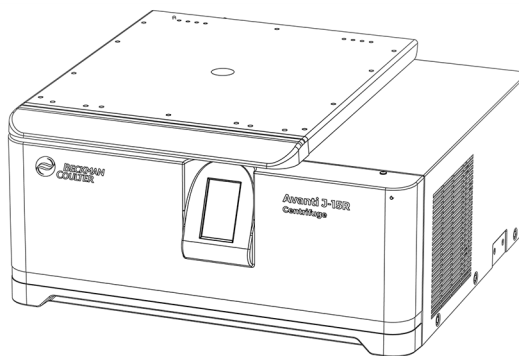

Instructions For Use

Avanti J-15 Series Centrifuges

Rx Only in the U.S.A.

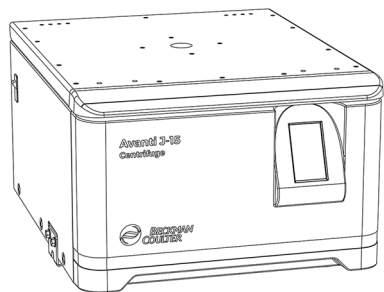

PN B80286AC
March 2018



Beckman Coulter, Inc.
250 S. Kraemer Blvd.
Brea, CA 92821 U.S.A.



Avanti J-15 Series Centrifuges for *In Vitro Diagnostic* Use

Instructions for Use

PN B80286AC (March 2018)

© 2018 Beckman Coulter, Inc.

All rights reserved

Beckman Coulter, the stylized logo, and the Beckman Coulter product and service marks mentioned herein are trademarks or registered trademarks of Beckman Coulter, Inc. in the United States and other countries.

All other trademarks, service marks, products, or services are trademarks or registered trademarks of their respective holders.

Contact Us

If you have any questions, contact our Customer Support Center.

- Worldwide, find us via our website at www.beckmancoulter.com/customersupport/support
- In the USA and Canada, call us at 1-800-369-0333.
- Outside of the USA and Canada, contact your local Beckman Coulter Representative.



www.beckmancoulter.com

EC REP

Beckman Coulter Eurocenter S.A.
22, rue Juste-Olivier
Case Postale 1044
CH - 1260 Nyon 1, Switzerland
Tel: +41 (0) 22 365 36 11

Original Instructions

Revision History

For updates, go to techdocs.beckmancoulter.com and download the most recent manual or system help for your instrument.

Initial Issue B80286AA, 05/2017

Issue AB, 09/2017

Changes or additions were made in the following: CHAPTER 1, Status Icons and Buttons; CHAPTER 1, Specifications.

Issue AC, 03/2018

Changes or additions were made in the following: [Table 1.3, Specifications](#); [Table 3.1, Diagnostics/User Messages Chart](#); CHAPTER 3, [Retrieving Your Sample in Case of a Power Failure](#); APPENDIX A, [Space and Location Requirements](#); [Figure A.2](#).

Note: *Changes that are part of the most recent revision are indicated in text by a bar in the left margin of the amended page.*

Safety Notice

Read all product manuals and consult with Beckman Coulter-trained personnel before attempting to operate instrument. Do not attempt to perform any procedure before carefully reading all instructions. Always follow product labeling and manufacturer's recommendations. If in doubt as to how to proceed in any situation, [contact us](#).

Beckman Coulter, Inc. urges its customers and employees to comply with all national health and safety standards such as the use of barrier protection. This may include, but is not limited to, protective eyewear, gloves, and suitable laboratory attire when operating or maintaining this or any other automated laboratory instrumentation. Wear Personal Protective Equipment (PPE) such as gloves, eye shields, and lab coats when performing any procedure. To avoid injury, observe and follow all the warnings and cautions throughout this manual.



If the equipment is used in a manner not specified by Beckman Coulter, Inc., the protection provided by the equipment may be impaired.

Alerts for Danger, Warning, Caution, and Note



All Dangers, Warnings, and Cautions in this document include an exclamation point, framed within a triangle.

The exclamation point symbol is an international symbol which serves as a reminder that all safety instructions should be read and understood before installation, use, maintenance, and servicing are attempted.



DANGER indicates an imminently hazardous situation which, if not avoided, will result in death or serious injury.



WARNING indicates a potentially hazardous situation which, if not avoided, could result in death or serious injury.



CAUTION indicates a potentially hazardous situation, which, if not avoided, may result in minor or moderate injury and/or mechanical damage.

NOTE NOTE is used to call attention to notable information that should be followed during installation, use, or servicing of this equipment.

Instrument Safety Precautions



Risk of operator injury if:

- All doors, covers and panels are not closed and/or secured in place prior to and during instrument operation.
- The integrity of safety interlocks and sensors is compromised.
- Instrument alarms and error messages are not acknowledged and acted upon.
- You contact moving parts.
- You mishandle broken parts.
- Doors, covers and panels are not opened, closed, removed and/or replaced with care.
- Improper tools are used for troubleshooting.

To avoid injury:

- Keep doors, covers and panels closed and/or secured in place while the instrument is in use.
- Take full advantage of the safety features of the instrument. Do not defeat safety interlocks and sensors.
- Acknowledge and act upon instrument alarms and error messages.
- Keep away from moving parts.
- Report any broken parts to your Beckman Coulter Representative.
- Open/remove and close/replace doors, covers and panels with care.
- Use the proper tools when troubleshooting.



System integrity could be compromised and operational failures could occur if this equipment is used in a manner other than specified. Operate the instrument as instructed in the Product Manuals.

 **CAUTION**

If you purchased this product from anyone other than Beckman Coulter or an authorized Beckman Coulter distributor, and if it is not presently under a Beckman Coulter Service Maintenance Agreement, Beckman Coulter cannot guarantee that the product is fitted with the most current mandatory engineering revisions or that you will receive the most current information bulletins concerning the product. If you purchased this product from a third party and would like further information concerning this topic, [contact us](#).

Cleaning

 **WARNING**

Risk of personal injury or contamination. Prior to cleaning equipment that has been exposed to hazardous material, contact the appropriate chemical and biological safety personnel. Always use the appropriate Personal Protective Equipment (PPE) when cleaning the centrifuge.

Observe the cleaning procedures outlined in the appropriate User's Manual for the Avanti J-15 instrument. Prior to cleaning equipment that has been exposed to hazardous material:

- Contact the appropriate Chemical and Biological Safety personnel.
- Review the Chemical and Biological Safety information in the user's manual.

Safety During Installation and/or Maintenance

 **WARNING**

Risk of personal injury or equipment damage. The J-15 centrifuge weighs 93 kg (205 lb). The J-15R centrifuge weighs 120 kg (265 lb). Do not attempt to lift or move it without assistance. Follow your safety officer's instructions regarding lifting heavy objects.

 **WARNING**

Risk of injury or equipment damage. Vapors from flammable reagents or combustible fluids could enter the centrifuge air system and be ignited by the motor. Do not use the centrifuge in the vicinity of flammable liquids or vapors, and do not run such materials in the instrument.

Perform only the maintenance described in the appropriate User's Manual for the Avanti J-15 Series Centrifuges. Maintenance other than that specified in the User's Manual should be performed only by a Beckman Coulter Representative.

IMPORTANT It is your responsibility to decontaminate components of the instrument before requesting service by a Beckman Coulter Representative or returning parts to Beckman Coulter for repair. Beckman Coulter will NOT accept any items which have not been decontaminated where it is appropriate to do so. If any parts are returned, they must be enclosed in a sealed plastic bag stating that the contents are safe to handle and are not contaminated.

Any servicing of this equipment that requires removal of any covers can expose parts that involve the risk of electric shock or personal injury. Make sure that the power switch is off and the centrifuge is disconnected from the main power source by removing the Mains (power) plug from the outlet receptacle, and refer such servicing to qualified personnel.

Do not replace any centrifuge components with parts not specified for use on this instrument.

Electrical Safety

High Voltage



To prevent electrically related injuries and property damage, properly inspect all electrical equipment prior to use and immediately report any electrical deficiencies. Contact a Beckman Coulter Representative for any servicing of equipment requiring the removal of covers or panels.

Do not place containers holding liquid on or near the chamber door. If they spill, liquid may get into the centrifuge and damage electrical or mechanical components.

Equipment Ratings

J-15	J-15R
100 VAC, 12A, 50/60 Hz	120 VAC, 12A, 60 Hz
120 VAC, 10A, 50/60 Hz	200-230 VAC, 8A, 50 Hz
200-230 VAC, 6A, 50/60-Hz	208-230 VAC, 9A, 60 Hz

 **DANGER**

To reduce the risk of electrical shock, the instrument uses a three-wire electrical cord and plug to connect it to earth-ground. Make sure that the matching wall outlet receptacle is properly wired and earth-grounded.

- Check that the line voltage agrees with the voltage listed on the name-rating plate affixed to the centrifuge.
- Never use a three-to-two wire plug adapter.
- Never use a two-wire extension cord or a two-wire non-grounding type of multiple-outlet receptacle strip.

NOTE The appliance coupler serves as the primary disconnecting device. Please ensure that the product has enough space so that a user has easy access to the appliance coupler.

Safety Against Risk of Fire

 **WARNING**

Risk of personal injury or equipment damage. This centrifuge is not designed for use with materials capable of developing flammable or explosive vapors or hazardous chemical reactions. Do not centrifuge such materials (such as chloroform or ethyl alcohol) in this centrifuge nor handle or store them within the 30-cm (1-ft) area surrounding the centrifuge.

Mechanical Safety

This device is intended for indoor use only.

Safety protection may be impaired if used in a manner not specified by the manufacturer.

 **WARNING**

Risk of personal injury or equipment damage. For safe operation of the equipment, observe the following:

- Use only the rotors and accessories designed for use in this centrifuge.
- Do not exceed the maximum rated speed of the rotor in use.
- NEVER attempt to slow or stop the rotor by hand.
- Do not lift or move the centrifuge while the rotor is spinning.
- NEVER attempt to override the door interlock system while the rotor is spinning.
- Maintain a 7.6-cm (3-in.) clearance envelope around the centrifuge while it is running. During operation you should come within the envelope only to adjust

instrument controls, if necessary.

- Never bring any flammable substances within the 30-cm (1-ft) area surrounding the centrifuge.
- Never lean on the centrifuge or place items on the centrifuge while it is operating.

Chemical and Biological Safety



WARNING

Risk of chemical injury from bleach. To avoid contact with the bleach, use barrier protection, including protective eyewear, gloves, and suitable laboratory attire. Refer to the Safety Data Sheet for details about chemical exposure before using the chemical.

If a hazardous substance such as blood is spilled on or in the instrument, rotors, or accessories, clean up the spill by using a high-quality, fragrance-free, gel-free bleach (5 to 6% solution of sodium hypochlorite - available chlorine) or ethanol solution, or use your laboratory decontamination solution. Then follow your laboratory procedure for disposal of hazardous materials. If the instrument, rotors, or accessories need to be decontaminated, [contact us](#).

Normal operation may involve the use of solutions and test samples that are pathogenic, toxic, or radioactive. Such materials should not be used in this centrifuge unless *all necessary safety precautions are taken*.

- Observe all cautionary information printed on the original solution containers prior to their use.
- Handle body fluids with care because they can transmit disease. No known test offers complete assurance that they are free of micro-organisms. Some of the most virulent—Hepatitis (B and C) and HIV (I–V) viruses, atypical mycobacteria, and certain systemic fungi—further emphasize the need for aerosol protection. Handle other infectious samples according to good laboratory procedures and methods to prevent spread of disease. Because spills may generate aerosols, observe proper safety precautions for aerosol containment.
- Use universal precautions when working with pathogenic materials. Means must be available to decontaminate the instrument and to dispose of biohazardous waste.
- Do not run toxic, pathogenic, or radioactive materials in this centrifuge without taking appropriate safety precautions. Biosafe containment should be used when Risk Group II materials (as identified in the World Health Organization *Laboratory Biosafety Manual*) are handled; materials of a higher group require more than one level of protection.
- Dispose of all waste solutions according to appropriate environmental health and safety guidelines.

It is your responsibility to decontaminate the centrifuge and accessories before requesting service by Beckman Coulter.



California Proposition 65:

This product may contain chemicals known to the State of California to cause cancer and birth defects or other reproductive harm.

Summary of Instrument Labels

High Voltage



This symbol indicates the potential of an electrical shock hazard existing from a high-voltage source and that all safety instructions should be read and understood before proceeding with the installation, maintenance, and servicing of the centrifuge.

Do not remove system covers. To avoid electrical shock, use supplied power cords only and connect to properly grounded (three-holed) outlets.

Recycling Label

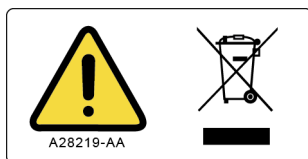

This symbol is required in accordance with the Waste Electrical and Electronic Equipment (WEEE) Directive of the European Union. The presence of this marking on the product indicates:

1. the device was put on the European market after August 13, 2005 and
2. the device is not to be disposed via the municipal waste collection system of any member state of the European Union.

It is very important that customers understand and follow all laws regarding the proper decontamination and safe disposal of electrical equipment. For Beckman Coulter products bearing this label please contact your dealer or local Beckman Coulter office for details on the take back program that will facilitate the proper collection, treatment, recovery, recycling and safe disposal of the device.

Multi-Compliance Label

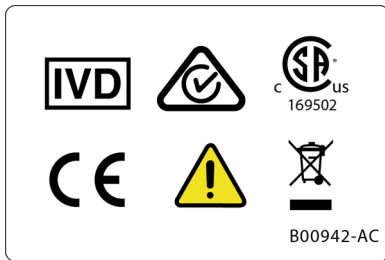

- IVD— For In Vitro Diagnostic Use.
- The “RCM” (Regulatory Compliance Mark) is depicted as a triangle with a partial circle and check. The mark is applied to products that comply with the EMC requirements of the Australian Communications Media Authority (ACMA) for use in Australia and New Zealand.
- 169502 – This label indicates recognition by a Nationally Recognized Testing Laboratory (NRTL) that the instrument has met the relevant product safety standards.

NOTE 169502 is applicable to North American models only.

- **CE**— A “CE” mark indicates that a product has been assessed before being placed on the market, and has been found to meet European Union safety, health, and/or environmental protection requirements.
- **Recycling** – Refer to the Recycling Label section in this document.

RoHS Notice











This label and materials declaration table (the Table of Hazardous Substance's Name and Concentration) are to meet People’s Republic of China Electronic Industry Standard SJ/T11364-2006 “Marking for Control of Pollution Caused by Electronic Information Products” requirements.

China RoHS Caution Label



This label indicates that the electronic information product contains certain toxic or hazardous substances. The center number is the Environmentally Friendly Useful Period (EFUP) date, and indicates the number of calendar years the product can be in operation. Upon the expiration of the EFUP, the product must be immediately recycled. The circling arrows indicate the product is recyclable. The date code on the label or product indicates the date of manufacture.

Instrument Labels

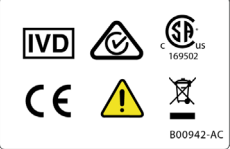
Name	Label	Meaning
Information		Caution Symbol — Serves as a reminder that all safety instructions should be read and understood before installation, use, maintenance, and servicing are attempted.
Biohazard		Biohazard Symbol— warns of the potential to be exposed to biological substances that carry a significant health risk.
Rotation Label		Indicates the direction of the spin of the rotor.
Ground Symbol		Ground Symbol— signifies the location of the ground connection (inlet receptacle to the chassis), which is considered the Protective Earthing Terminal.
Name-Rating Plate		The company name.
		Model Number
		Serial Number The Serial number is formatted with a 3 digit prefix, followed by a two digit year, a one digit letter signifying the month, and a two digit build sequence number.
		Located next to this symbol is the contact information for the EC (European Commission) representative.
		Consult Instructions For Use
		The Manufacturer Symbol indicates the name and address of the manufacturer.
		Date of Manufacture symbol indicates the date of manufacture as YYYY-MM-DD
Multi-Compliance Label		See Multi-Compliance Label .

Contents

Revision History, iii

Safety Notice, v

Alerts for Danger, Warning, Caution, and Note, v
Instrument Safety Precautions, vi
Cleaning, vii

Safety During Installation and/or Maintenance, vii

Electrical Safety, viii
High Voltage, viii

Safety Against Risk of Fire, ix

Mechanical Safety, ix

Chemical and Biological Safety, x

Summary of Instrument Labels, xi
High Voltage, xi
Recycling Label, xi
Multi-Compliance Label, xii
RoHS Notice, xii
China RoHS Caution Label, xii

Instrument Labels, xiii

Introduction, xxi

Intended Use, xxi

Certification, xxi

Scope of Manual, xxi

Conventions, xxii
Typographic Conventions, xxii

CFC-Free Centrifugation, xxii

EMC Compliance, xxii

CHAPTER 1: System Description, 1-1

Introduction, 1-1

Centrifuge Function and Safety Features, 1-1
Centrifuge Function, 1-1
Safety Features, 1-2

Centrifuge Chassis, 1-2

- Housing, 1-2
- Door, 1-3
- Rotor Chamber, 1-3
- Temperature Sensing and Control (J-15R only), 1-3
- Drive, 1-3

- Controls and Indicators, 1-4
 - Power Switch, 1-4
 - Control Panel, 1-4
 - Digital Display, 1-5
 - Status Icons, 1-6
 - Parameter Setting Screens, 1-8

- Specifications, 1-10

- Available Rotors, 1-12

CHAPTER 2: Operation, 2-1

- Introduction, 2-1

- Installing the Rotor, 2-2

- Manual Run, 2-3

 - Speed, 2-4

 - Radius, 2-6

 - Time, 2-6

 - Temperature (J-15R only), 2-8

 - Acceleration/Deceleration, 2-9

 - Start, 2-10

 - Pulse Function, 2-11

- Programmed Run, 2-11

 - Create a New Program, 2-13

 - Use an Existing Program, 2-14

 - Edit an Existing Program, 2-15

 - Delete a Program, 2-16

 - Setting a Security PIN Number, 2-18

- Menu Screen, 2-19

 - Diagnostic Messages, 2-19

 - Disable/Enable the Audible Tones, 2-22

 - Service, 2-23

 - Information, 2-23

CHAPTER 3: Troubleshooting, 3-1

- Introduction, 3-1

- Diagnostics/User Messages Chart, 3-1

- Other Possible Problems, 3-5

- Retrieving Your Sample in Case of a Power Failure, 3-7

CHAPTER 4: Care and Maintenance, 4-1

Introduction, 4-1

Instrument Care, 4-1

 Maintenance, 4-1

 Cleaning, 4-2

 Tube Breakage, 4-3

 Decontamination, 4-3

 Sterilization and Disinfection, 4-4

Circuit Breaker and Fuses, 4-4

Storage and Transport, 4-4

Supply List, 4-5

 Replacement Parts, 4-5

 Supplies, 4-5

APPENDIX A: Installation, A-1

Introduction, A-1

Space and Location Requirements, A-2

Securing the Centrifuge, A-4

 Securing the Centrifuge to a Bench, A-4

Electrical Requirements, A-4

Test Run, A-5

Abbreviations

Index

Beckman Coulter, Inc.

Avanti J-15 Series Centrifuge Warranty

Symbols

Related Documents

Illustrations

- 1.1 Avanti J-15 and J-15R Centrifuges, 1-1
- 1.2 Power Switch Location, 1-4
- 1.3 Information Page, 1-4
- 1.4 Control Panel, 1-5
- 1.5 Home Screen, 1-6
- 1.6 Speed (RPM) Setting Screen, 1-8
- 2.1 Home Screen, 2-3
- 2.2 Run Speed Display, 2-5
- 2.3 Speed Keypad, 2-5
- 2.4 Time Display, 2-7
- 2.5 Time Keypad, 2-7
- 2.6 Temperature Display, 2-8
- 2.7 Temperature Keypad, 2-8
- 2.8 Acceleration/Deceleration Settings Screen, 2-9
- 2.9 Program Library, 2-11
- 2.10 Program Settings Screen, 2-13
- 2.11 Program Settings Screen, 2-15
- 2.12 Delete Program Confirmation Screen, 2-17
- 2.13 Security Pin Entry Screen, 2-18
- 2.14 Menu Screen, 2-19
- 2.15 Diagnostic Messages, 2-20
- 2.16 Diagnostics List, 2-20
- 2.17 Diagnostic History, 2-21
- 2.18 Diagnostics Screen — Settings and Conditions, 2-22
- 2.19 Information Screen, 2-24
- 3.1 Door Latch Override, 3-7
- A.1 Ventilated Instrument Intake Cover, A-1
- A.2 Avanti J-15 Centrifuge Dimensions (cm/in), A-3
- A.3 Avanti J-15R Centrifuge Dimensions (cm/in), A-3

Tables

- [Equipment Ratings, 1-viii](#)
- 1.1 [Status Icons and Buttons, 1-6](#)
- 1.2 [Run Parameter Icons, 1-9](#)
- 1.3 [Specifications, 1-10](#)
- 1.4 [Available Rotors, 1-12](#)
- 2.1 [Acceleration and Deceleration Rates \(in Minutes: Seconds\) to and from Maximum Speed, 2-10](#)
- 3.1 [Diagnostics/User Messages Chart, 3-2](#)
- 3.2 [Troubleshooting Chart, 3-6](#)

Intended Use

For *In Vitro* Diagnostic Use.

This Avanti J-15 Series centrifuge is intended for the separation of components through the use of relative centrifugal force.

It is designed to separate human samples, including blood and other body fluids, for processing, analysis, and in vitro diagnostic testing, as well as nonhuman body samples and chemicals, including industrial and environmental samples.

This centrifuge should be operated by qualified professionals only.

Certification

Beckman Coulter Avanti J-15 series centrifuges are manufactured in a facility that maintains certifications to both ISO 9001:2008 and ISO 13485:2012. They have been designed and tested to be compliant (when used with Beckman Coulter rotors) with the laboratory equipment requirements of applicable regulatory agencies. Declarations of conformity and certificates of compliance are available at www.beckmancoulter.com.

Scope of Manual

This manual is designed to familiarize you with the Beckman Coulter Avanti J-15 series centrifuges, their functions, specifications, operation, and routine operator care and maintenance. Beckman Coulter recommends that you read this entire manual, especially the *Safety Notice* and all safety-related information, before operating the centrifuge or performing instrument maintenance.

- [CHAPTER 1, System Description](#) contains system specifications and a brief physical and functional description of the centrifuge, including the operating controls and indicators.
- [CHAPTER 2, Operation](#) contains centrifuge operating procedures.
- [CHAPTER 3, Troubleshooting](#) lists diagnostic messages and other possible malfunctions, together with probable causes and suggested corrective actions.
- [CHAPTER 4, Care and Maintenance](#) contains procedures for routine operator care and maintenance, as well as a brief list of supplies and replacement parts.

- [APPENDIX A, Installation](#) provides requirements for preparing laboratory facilities and installing the centrifuge.

NOTE If the centrifuge is used in a manner other than specified in this manual, the safety and performance of this equipment could be impaired. Further, the use of any equipment other than that recommended by Beckman Coulter has not been evaluated for safety. Use of any equipment not specifically recommended in this manual and/or the applicable rotor manual is the sole responsibility of the user.

Conventions

Certain symbols are used in this manual to call out safety-related and other important information. These international symbols may also be displayed on the centrifuge and are reproduced in [Symbols](#).

Typographic Conventions

Certain typographic conventions are used throughout this manual to distinguish names of user interface components, such as keys and displays.

- *Icon names* (for example, **START** or **ADD PROGRAM**) appear in capital letters in boldface type.
- Selections that describe a screen (for example, **Home** or **Manual Control**) are in boldface.
- The path to a specific function or screen appears with the greater than (>) symbol between succeeding screen options, like this: **MENU > INFORMATION**.
- Links to information in another part of the document are in blue. To access the linked information, select the blue text.

CFC-Free Centrifugation

To ensure minimal environmental impact, no CFCs are used in the manufacture or operation of Avanti J-15 series centrifuges.

EMC Compliance

This IVD equipment complies with the emission and immunity requirements described in IEC 61326-1 and 61326-2-6 Series.

This equipment has been designed and tested to CISPR 11 Class A and intended for Commercial/Industrial environments. If used in a domestic environment, it may cause radio interference, in which case you may need to take measures to mitigate the interference.

The electromagnetic environment should be evaluated prior to operation of the equipment.

Do not use this equipment in close proximity to sources of strong electromagnetic radiation (e.g. unshielded intentional RF sources), as these may interfere with proper operation.

Introduction

This chapter provides a brief physical and functional description of the Beckman Coulter Avanti J-15 Series centrifuges. The operating controls and indicators are also described; instructions for their use are in [CHAPTER 2, Operation](#). Chemical compatibilities of materials listed in this manual can be found in Chemical Resistances (publication IN-175). Refer to the applicable rotor manuals for rotor descriptions.

Sections in this chapter include:

- [Centrifuge Function and Safety Features](#)
- [Centrifuge Chassis](#)
- [Controls and Indicators](#)
- [Specifications](#)
- [Available Rotors](#)

Centrifuge Function and Safety Features

Figure 1.1 Avanti J-15 and J-15R Centrifuges

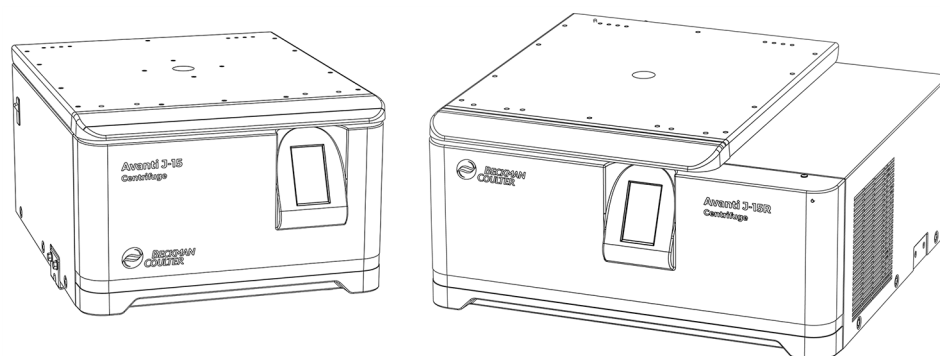

Centrifuge Function

The Beckman Coulter Avanti J-15 series centrifuges ([Figure 1.1](#)) are benchtop centrifuges that generate centrifugal forces required for a wide variety of applications. Together with the Beckman Coulter rotors designed for use in this centrifuge, the centrifuge applications include:

- Routine processing such as sample preparations, pelleting, extractions, purifications, concentrations, phase separations, receptor binding, and column centrifugations.
- Cell isolation.

- Binding studies and separation of whole blood.
- Processing large numbers of small-volume samples in multiwell plates for concentrating tissue-culture cells, cloning and replicate studies, in-vitro cytotoxicity studies, receptor binding, and genetic engineering experimentation.
- Rapid sedimentation of protein precipitates, large particles, and cell debris.

The Avanti J-15 series centrifuges are microprocessor-controlled, providing interactive operation. The instrument design features a brushless asynchronous motor, automatic rotor identification system, program memory that enables repeated run conditions, and a choice of acceleration and deceleration profiles. The J-15R features a temperature control system as well. Audible and visual indicators alert the operator to conditions that may need attention.

Safety Features

The Avanti J-15 series centrifuge has been designed and tested to operate safely indoors at altitudes up to 2000 m (6562 ft). Safety features include the following.

- An electromechanical door lock system prevents operator contact with spinning rotors and prevents run initiation unless the door is shut and locked. The door is locked when a run is in progress and can be opened only when the rotor is stopped by selecting **OPEN DOOR** . If there is a power failure, the door can be manually unlocked for sample recovery (see [CHAPTER 3, Troubleshooting](#)).
- A steel barrier surrounds the rotor chamber to provide full operator protection.
- A rotor model identification system prevents the installed rotor from running above its maximum rated speed. During acceleration the microprocessor checks that the identified rotor is supported. Speed is limited to the maximum safe speed of the identified rotor. If the system determines that the set speed exceeds the maximum rated speed of the rotor, the system displays an error message and reduces the speed to the maximum allowable speed of the rotor.
- An imbalance detector monitors the rotor during the run, causing automatic shutdown if rotor loads are severely out of balance. At low speeds, an incorrectly loaded rotor can cause imbalance. Rotor instability can also occur if the centrifuge is moved while running, or if it is not resting on a level and secure surface (see [CHAPTER 3, Troubleshooting](#)).

Centrifuge Chassis

Housing

The centrifuge housing is made of sheet steel with a powder coated finish. The LCD touch panel display provides the user control interface and displays system information and alerts.

Door

The painted aluminum and plastic door is secured to the housing by solid hinges. A window in the center allows strobe viewing. When the door is closed, the locking system engages. The door is locked when a run is in progress and can be opened only when the rotor is stopped and

OPEN DOOR  is selected. If there is a power failure, the door lock can be manually tripped for sample recovery (see [CHAPTER 3, Troubleshooting](#)).

Rotor Chamber

The rotor chamber is made of stainless steel and is sealed by a foam gasket.

Temperature Sensing and Control (J-15R only)

With the power on, the temperature control system is activated when the door is closed and locked. A sensor in the rotor chamber continuously monitors chamber temperature. The microcontroller adjusts the chamber temperature to the temperature entered by the user. The temperature can be set between -10 and $+40^{\circ}\text{C}$.

NOTE To avoid chamber icing, refrigeration is off when the door is open. The centrifuge door must be closed and locked for the refrigeration system to begin operating.

Drive

The asynchronous direct-drive motor is brushless for a clean, quiet operation. The resilient suspension ensures that loads will not be disturbed by vibration, and prevents damage to the drive shaft if an imbalance occurs during centrifugation. Maximum acceleration and deceleration may be selected to allow fast processing of samples. Alternately, delicate gradients may be preserved using slower acceleration and deceleration.

Controls and Indicators

Power Switch

Figure 1.2 Power Switch Location

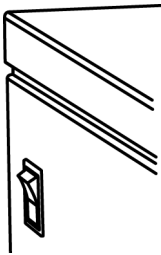

The power switch, located on the left side of the centrifuge, controls electrical power to the centrifuge. It is also a circuit breaker that will trip to cut off power in the event of a power overload. The power switch must be turned on before the chamber door can be opened.

Control Panel

Figure 1.3 Information Page

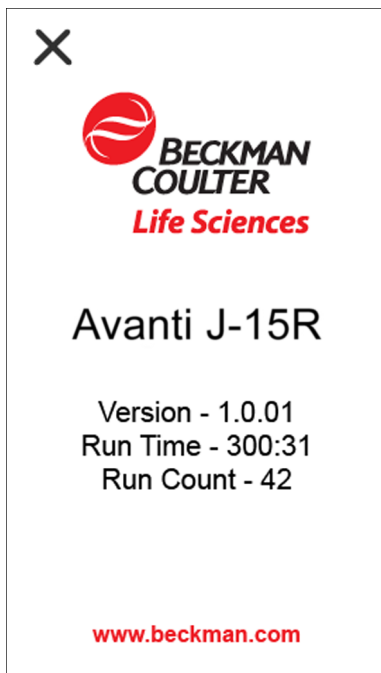

The control panel ([Figure 1.4](#)) is mounted at an angle on the centrifuge front for easy visibility and access. It is used to enter run parameters via the touch screen, and to display run parameters, program information, and user messages.

Figure 1.4 Control Panel

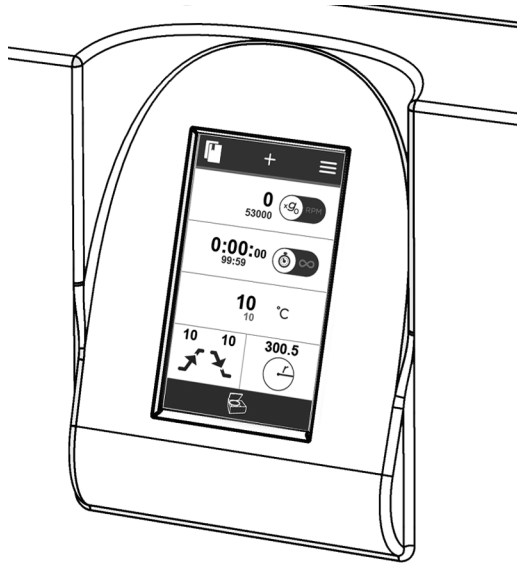

Digital Display

The touch screen ([Figure 1.5](#)) is both the information display and the control input for the instrument. The screen is segmented into separate areas that display different aspects of a run, such as speed, time, and acceleration/deceleration settings. When an area on the screen is touched, that control is activated or the screen changes to another screen, such as parameter settings for that control. Each component of the touch screen interface is explained in [CHAPTER 2, Operation](#).

Figure 1.5 Home Screen

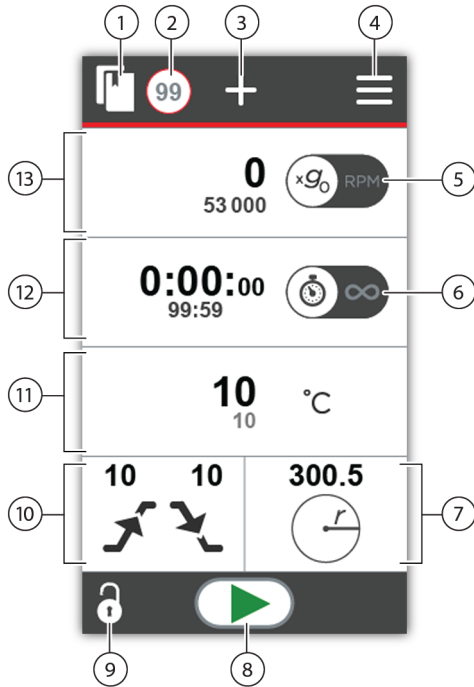

1. **PROGRAMS** — Select to see all saved programs.
2. **PROGRAM NUMBER** — Shows current program. If no program is selected, this is not shown.
3. **ADD PROGRAM** — Select to create a new program.
4. **MENU** — Select to see diagnostics, sound control, and product information.
5. **RPM/RCF MODE toggle** — Select to switch between RCF and RPM.
6. **TIMED MODE/HOLD MODE toggle** — Select to switch between a timed run and a hold run.
7. **RADIUS** — Select to set radius.
8. **START** — Select to start a run.
9. **OPEN DOOR** — Select to open the door.
10. **ACCELERATION/DECELERATION PROFILE** — Select to change acceleration and deceleration rates.
11. **TEMPERATURE (J-15R only)** — Displays current temperature. Select to set the temperature.
12. **TIME** — Displays current remaining time and set time. Select to set a timed run. If **HOLD MODE** is selected, displays elapsed run time.
13. **SPEED (RCF showing)** — Displays current speed and set speed. Select to change speed.

Status Icons

Status icons display the current status of the instrument.

Table 1.1 Status Icons and Buttons





LIBRARY		Select to show stored programs.
PROGRAM NUMBER		Shows the current program. Select to change program settings.
ADD A NEW PROGRAM		Select to add a new program.
MENU		Select to view diagnostics, sound control, and product information.

Table 1.1 Status Icons and Buttons (Continued)











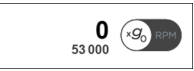



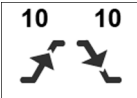
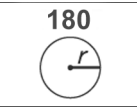

<p>SPEED</p>		<p>The large number displays the actual value during a run. The small number displays the set value in RCF.</p> <ul style="list-style-type: none"> • RPM MODE : the rotor speed is shown in revolutions per minute (RPM). • RCF MODE : the rotor speed is shown in relative centrifugal force (RCF).
<p>TIME</p>		<p>The large numbers display the actual value during a run. The small numbers display the set value in hours:minutes.</p> <ul style="list-style-type: none"> • TIME MODE : run time is shown in remaining hours, minutes, and seconds. • HOLD MODE : elapsed time is shown in hours, minutes, and seconds. <p>NOTE In HOLD MODE, the set time is overridden.</p>
<p>TEMPERATURE (J-15R only)</p>		<p>The large number shows the current temperature in degrees Celsius. The small number displays the set value.</p> <p>Select to enter temperature (using the keypad), from –10 to +40°C. If a new temperature is not entered, the centrifuge uses the temperature set for the previous run.</p>
<p>ACCELERATION/ DECELERATION PROFILES</p>		<p>Displays the Acceleration and Deceleration profiles.</p> <p>Select to set the Acceleration and Deceleration Profile. Provides ten preset acceleration and eleven preset deceleration rates (see Table 2.1 in CHAPTER 2). If no acceleration or deceleration rate is selected, the centrifuge uses the acceleration and deceleration settings from the previous run. (Deceleration rate 0 is always coast to a complete stop with no brake.)</p>
<p>RADIUS</p>		<p>Displays Radius when RCF mode is selected.</p> <p>Select to set Radius.</p> <p>Refer to <i>JS-4.750 Swinging-Bucket Rotor Instructions For Use</i> (B80289) and <i>JA-10.100 Fixed-Angle Rotor Instructions For Use</i> (B80290), for radius settings for rotors and accessories.</p>
<p>OPEN DOOR</p>		<p>Unlatches the door.</p>
<p>DOOR AJAR</p>		<p>Indicates the door is not properly latched.</p>
<p>DOOR OPEN</p>		<p>Indicates the door is open.</p>

Table 1.1 Status Icons and Buttons (*Continued*)

START		Press to start a run.
STOP		Press to stop a run.
RUN IN PROGRESS		Indicates a run is in progress.
ERROR		Error message includes a diagnostic code. Red background — the condition has not been cleared. Orange background — the condition is cleared, but the condition has not been acknowledged by the user. See CHAPTER 2, Diagnostic Messages , and CHAPTER 3, Diagnostics/User Messages Chart .
ERROR WITH LOCKOUT		Error message includes a diagnostic code, and may include a countdown of the time remaining before the door can be opened. See CHAPTER 2, Diagnostic Messages , and CHAPTER 3, Diagnostics/User Messages Chart .
IMBALANCE		Orange background with an imbalance symbol — indicates an imbalance condition. When the user acknowledges the diagnostic, A700 will be displayed in the diagnostics list. See CHAPTER 2, Diagnostic Messages , and CHAPTER 3, Diagnostics/User Messages Chart .

Parameter Setting Screens

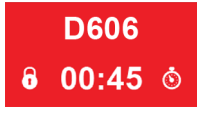
Run-parameter keys are used to enter specific run information. The centrifuge emits an audible tone when each key is pressed. Instructions for disabling the tone are in [CHAPTER 2, Operation](#).

Figure 1.6 Speed (RPM) Setting Screen

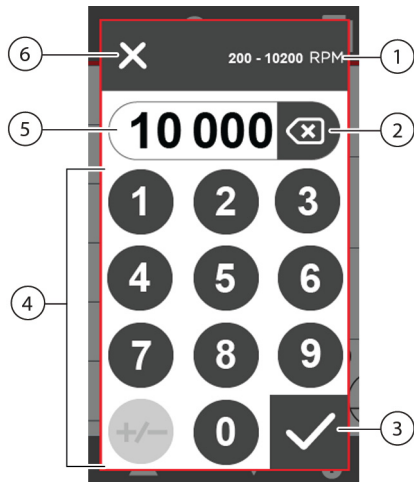

1. Available range
2. BACKSPACE
3. ACCEPT ENTRY
4. Keyboard (+/- not available)
5. Setting display
6. CANCEL

Table 1.2 Run Parameter Icons















	<p>PLUS/MINUS (J-15R only) — In the Temperature settings, press to change the setting to a temperature above or below 0°C.</p>
	<p>ACCEPT ENTRY — Press to accept settings in Time, Temperature, Radius, Speed, RCF, and the Acceleration and Deceleration Profile. Closes the window.</p>
	<p>CANCEL — Press to cancel the action and return to the previous screen.</p>
	<p>SAVE SETTINGS — In the Program screen, press to save settings.</p>
	<p>DELETE PROGRAM — In the Program screen, press to delete the selected program.</p>
	<p>SECURITY PIN NUMBER REQUIRED — In the Program screen, press to enter a required security PIN number.</p>
	<p>SECURITY PIN NUMBER NOT REQUIRED — In the Program screen, press to add a security PIN number.</p>
	<p>DIAGNOSTIC - RUN SETTINGS — In the Diagnostic History, press to display the instrument settings at the time of the error.</p>
	<p>DIAGNOSTIC - RUN CONDITIONS — In the Diagnostic History screen, press to display the instrument conditions at the time of the error.</p>
	<p>SEARCH — In the Program screen, press to search for a specific program number.</p>
	<p>DIAGNOSTIC — In the Menu screen, press to open the Diagnostic History screen.</p>
	<p>SOUND ON — In the Menu screen, press to turn the sounds off.</p>

Table 1.2 Run Parameter Icons (Continued)

	SOUND OFF — In the Menu screen, press to turn the sounds on.
	SERVICE — For Beckman Coulter Service Use only.
	INFORMATION — In the Menu screen, press to see instrument and software information.

Specifications

Only values with tolerances or limits are guaranteed data. Values without tolerances are informative data, without guarantee.

Table 1.3 Specifications

Specification		J-15 Ventilated	J-15R Refrigerated
Speed	Set Speed	200 to 10,200 RPM in 10 RPM increments	200 to 10,200 RPM in 10 RPM increments
	Set RCF	10 to 11,420 x g in 10 x g increments	10 to 11,420 x g in 10 x g increments
	Speed Display	actual rotor speed in 10 RPM increments or actual RCF in 10 x g increments	
	Speed Accuracy	±25 rpm of Set Speed from 200 to 10,200 RPM	
Time	Set Time	1 minute to 99 hours 59 minutes or continuous (hold)	
	Time Display	Timed Run: indicates run time remaining (HH:MM:SS) Hold Run: indicates elapsed time (HH:MM:SS) Pulse Run: indicates elapsed time (HH:MM:SS)	
Temperature	Set Temperature	N/A	-10 to +40°C in 1°C increments ^a
	Temperature Display		Chamber temperature in 1°C increments
	Temperature Accuracy ^a		±2°C of Chamber temperature (after equilibration); applies to 4 to 25°C temperature range
	Over Temperature Shutdown ^b	>55°C	>55°C
Acceleration	Acceleration Profiles	10 acceleration rates, including maximum torque	
Deceleration	Deceleration Profiles	11 deceleration rates, including maximum torque and no braking	

Table 1.3 Specifications (Continued)

Specification		J-15 Ventilated	J-15R Refrigerated
Dimensions	Width	55.6 cm (21.9 in.)	75.6 cm (29.8 in)
	Depth	74.9 cm (29.5 in)	70.3 cm (27.7 in)
	Height	36.8 cm (14.5 in)	36.8 cm (14.5 in)
Weight	Weight, not including rotor	93 kg (205 lbs)	120 kg (265 lbs)
Ventilation clearances^c	Sides	7.6 cm (3.0 in.)	
	Rear	7.6 cm (3.0 in.)	
Finishes	Top Surface	Painted steel	
	Front Surface	Uncoated plastic	
	Door	Painted Aluminum and plastic	
Electrical	Electrical Requirements	100 VAC, 12A, 50/60 Hz 120 VAC, 10A, 50/60 Hz 200-230 VAC, 6A, 50/60-Hz	120 VAC, 12A, 60 Hz 200-230 VAC, 8A, 50 Hz 208-230 VAC, 9A, 60 Hz
	Electrical Supply	Class 1	
	Installation (overvoltage) category	II	
Environmental	Noise output (1 m in front of instrument, 1.5 m above the floor with JA-10.100 rotor at 10,200 rpm)	61 dBA	58 dBA
	Ambient Temperature Range	10 to 31°C	10 to 35°C
	Humidity	80% non-condensing	80% non-condensing
	Refrigerant	N/A	R404A
	Maximum heat dissipation into room under steady-state conditions	4095 Btu/h (1.2kW)	120V: 4913 Btu/h (1.44kW) 200-230V: 6551 Btu/h (1.92 kW)
	Pollution degree	2 ^d	
	Altitude	up to 2000 meters	

- a. Display Temperature vs. Chamber Temperature: To reach temperatures above ambient, the centrifuge is dependent on the frictional heat generated inside the chamber during operation. At low run speeds or low ambient temperatures, the centrifuge may not be able to achieve some higher temperatures. At high run speeds or high ambient temperatures, the centrifuge may not be able to achieve some lower temperatures.
- b. If the system reaches this temperature, it will issue a diagnostic and shut down using maximum brake.
- c. When operating the J-15 Centrifuge, maintain a 30 cm (12 in.) clearance envelope around the centrifuge under the following circumstances: 1) Run duration exceeds 60 minutes or 2) Ambient temperature exceeds 25°C.
- d. Normally only nonconductive pollution occurs; occasionally however, a temporary conductivity caused by condensation must be expected.

Available Rotors

The following Beckman Coulter rotors can be used in the Avanti J-15 and J-15R centrifuges. The rotors are described in individual manuals that accompany each rotor.

Table 1.4 Available Rotors

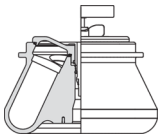
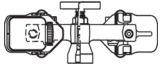
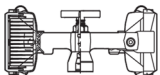
Rotor Profile	Description	Max RPM ^a		Max RCF ^b ($\times g$) at r_{\max}		Number of Tubes \times Nominal Capacity	Rotor Manual Number
		J-15	J-15R	J-15	J-15R		
	JA-10.100 Fixed Angle $r_{\max} = 98.0$ mm $r_{\min} = 35.0$ mm	10,200	10,200	11420 $\times g$	11420 $\times g$	6 \times 100 mL	B80290
	JS-4.750 Swinging Bucket Tube-and-bottle buckets $r_{\max} = 207.8$ mm	4550	4550 for 120V unit.	4820 $\times g$	4820 $\times g$ for 120V unit	4 \times 750 mL	B80289
			4750 for 200-230V unit		5250 $\times g$ for 200-230V unit		
	JS-4.750 Swinging Bucket Multiwell-plate carriers, $r_{\max} = 183.2$ mm	1 to 3 stacked plates: 4350	1 to 3 stacked plates: 4450	3880 $\times g$	4060 $\times g$	4 \times 3 \times 96 mL	B80289
		4 stacked plates: 2700	4 stacked plates: 2700	1500 $\times g$	1500 $\times g$	4 \times 4 \times 96 mL	B80289

a. Maximum speeds are based on a solution density of 1.2 g/mL. At upper temperature and humidity ambient conditions, swinging bucket rotor speed may require reduction.

b. Relative Centrifugal Field (RCF) is the ratio of the centrifugal acceleration at a specified radius and speed ($r\omega^2$) to the standard acceleration of gravity (g) according to the following formula: $RCF = r\omega^2/g$ —where r is the radius in millimeters, ω is the angular velocity in radians per second (2π RPM/60), and g is the standard acceleration of gravity (9807 mm/s²). After substitution: $RCF = 1.12 r$ (RPM/1000)².

Introduction

This section contains centrifuge operating procedures. A summary is provided at the start of this section. If you are an experienced user of this centrifuge, you can turn to the summary for a quick review of operating steps. Refer to the applicable rotor manual for instructions on preparing the rotor for centrifugation.

Sections in this chapter include:

- *Installing the Rotor*
- *Manual Run*
- *Programmed Run*
- *Menu Screen*

 **WARNING**

Risk of injury or equipment damage. Vapors from flammable reagents or combustible fluids could enter the centrifuge air system and be ignited by the motor. Do not use the centrifuge in the vicinity of flammable liquids or vapors, and do not run such materials in the instrument.

 **WARNING**

Risk of contamination. No known test offers complete assurance that they are free of micro-organisms. Some of the most virulent — Hepatitis (B and C) and HIV (I–V) viruses, atypical mycobacteria, and certain systemic fungi — further emphasize the need for aerosol protection. Handle other infectious samples according to good laboratory procedures and methods to prevent spread of disease. Because spills may generate aerosols, observe proper safety precautions for aerosol containment. Handle body fluids with care because they can transmit disease.

Do not run toxic, pathogenic, or radioactive materials in this centrifuge without taking appropriate safety precautions. Biosafe containment should be used when Risk Group II materials (as identified in the World Health Organization *Laboratory Biosafety Manual*) are handled; materials of a higher group require more than one level of protection.

Installing the Rotor

Prepare the rotor for centrifugation as described in the applicable rotor manual (refer to *JA-10.100 Fixed-Angle Rotor Instructions For Use* (B80290) or *JS-4.750 Swinging-Bucket Rotor Instructions For Use* (B80289)).

NOTE For runs at temperatures cooler than ambient room temperature, refrigerate the rotor beforehand for fast equilibration.

NOTE The power must be turned on before the chamber door can be unlocked and opened.

NOTE To end a run for any reason, do not turn the power switch off; press **STOP**  instead.

To install a rotor:

1 Turn the power switch on.

2 Select **OPEN DOOR** .

NOTE This command will only be available when the rotor is at a complete stop.

3 Install the rotor according to directions in the rotor manual (refer to *JA-10.100 Fixed-Angle Rotor Instructions For Use* (B80290) or *JS-4.750 Swinging-Bucket Rotor Instructions For Use* (B80289)).

- Ensure that the rotor is seated on the drive hub.
- Avoid bumping the display panel keys during rotor installation or removal.

NOTE Before installing the rotor, ensure the drive hub is sufficiently lubricated. See [CHAPTER 4, Maintenance](#) for instructions.

4 Close the chamber door by pressing down firmly on both sides.
When the door is properly latched, the **START** button appears.

Manual Run

When a run-parameter key (**SPEED, TIME, TEMPERATURE, ACCEL/DECEL, RADIUS**) is selected, a parameter can be entered or changed.

Figure 2.1 Home Screen

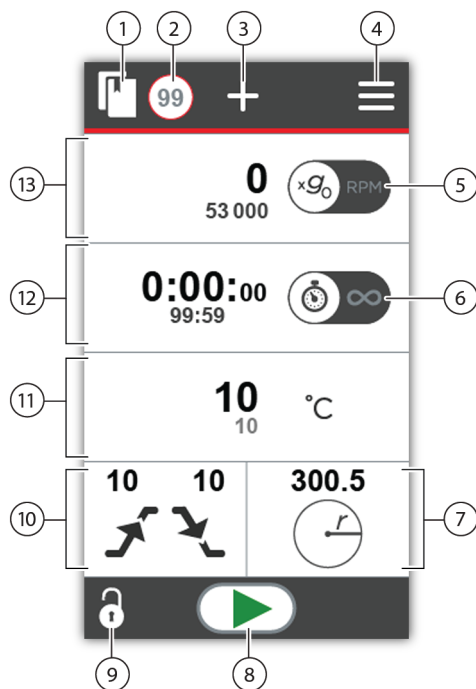



1. **PROGRAMS** — Select to see all saved programs (see [Programmed Run](#)).
2. **PROGRAM NUMBER** — Shows current program. If no program is selected, this is not shown.
3. **ADD PROGRAM** — Select to create a new program (see [Create a New Program](#)).
4. **MENU** — Select to see diagnostics, sound control, and product information (see [Menu Screen](#)).
5. **RPM/RCF MODE toggle** — Select to switch between RCF and RPM (see [Speed](#)).
6. **TIMED MODE/HOLD MODE toggle** — Select to switch between a timed run and a hold run (see [Time](#)).
7. **RADIUS** — Select to set radius (see [Radius](#)).
8. **START** — Select to start a run (see [Start](#)).
9. **OPEN DOOR** — Select to open the door.
10. **ACCELERATION/DECELERATION PROFILE** — Select to change acceleration and deceleration rates (see [Acceleration/Deceleration](#)).
11. **TEMPERATURE (J-15R only)** — Displays the current temperature and set temperature. Select to set the temperature (see [Temperature \(J-15R only\)](#)).
12. **TIME** — Displays current remaining time and set time. Select to set a timed run. If **Hold Mode** is selected, displays elapsed run time (see [Time](#)).
13. **SPEED (RCF showing)** — Displays current speed and set speed. Select to change speed (see [Speed](#)).



To Perform a Manual Run:

- 1 Turn the power switch on (I).
- 2 Press **OPEN DOOR**  to open the chamber door; lift the door open.
- 3 Install the rotor according to the applicable rotor manual (refer to *JA-10.100 Fixed-Angle Rotor Instructions For Use* (B80290) or *JS-4.750 Swinging-Bucket Rotor Instructions For Use* (B80289)). Close the door.

NOTE Before installing the rotor, ensure the drive hub is sufficiently lubricated. See [CHAPTER 4, Care and Maintenance](#) for instructions.

-
- 4 Set the run parameters. (See [Speed](#), [Time](#), [Temperature \(J-15R only\)](#), [Acceleration/Deceleration](#), [Radius](#))
- Select the setting. The parameter setting screen opens.
 - Use the keypad to enter a new setting.
 - Select **ACCEPT ENTRY** . The screen reverts to the **Home** screen.
-

- 5 Check that all parameters are correct. Ensure the door is properly latched, and press **START** .
-

- 6 Wait for the time to count down to zero, or end the run by pressing **STOP** .
- NOTE** (To end a run for any reason, do not turn the power switch off; press **STOP**  instead).
-

- 7 When the rotor stops, a tone sounds. Select **OPEN DOOR**  to open the chamber door; lift the door.
-

Speed



Enter a run speed, up to the maximum speed of the rotor in use. Or enter a relative centrifugal field (RCF) value, up to the maximum achievable RCF of the rotor (see also [Radius](#)).

NOTE The maximum speed (and RCF) of the JS-4.750 rotor varies by instrument and model.

- **J-15R Refrigerated Centrifuge:**
 - When using multiwell-plate carriers on the JS-4.750 rotor, limit rotor speed to 4450 RPM when running up to three stacked Beckman Coulter plates separated by cap strips. Reduce speed to 2700 RPM if running four stacked plates.
 - J-15R 120 VAC: When using the tube and bottle buckets, maximum speed is 4550 RPM.
- **J-15 Ventilated Centrifuge**
 - When using multiwell-plate carriers on the JS-4.750 rotor, limit rotor speed to 4350 RPM when running up to three stacked Beckman Coulter plates separated by cap strips. Reduce speed to 2700 RPM if running four stacked plates.
 - When using tube and bottle buckets, maximum speed is 4550 RPM.

Set rotor speed using RPM values; or enter Rmax values, then enter the RCF.

To Set the Run Speed:

1 Select  or  to toggle between the **RPM** and **RCF** modes (Figure 2.2).

2 Select the **SPEED** display (Figure 2.2). The **Run Speed** setting screen opens.

Figure 2.2 Run Speed Display

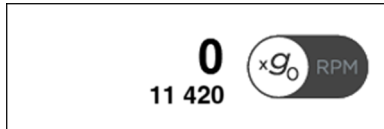

3 Use the keypad (Figure 2.3) to enter the desired Run Speed or RCF.

NOTE The display will always include a zero. Ensure the number shown in the entered settings window is correct before selecting **Accept Entry**.

Figure 2.3 Speed Keypad

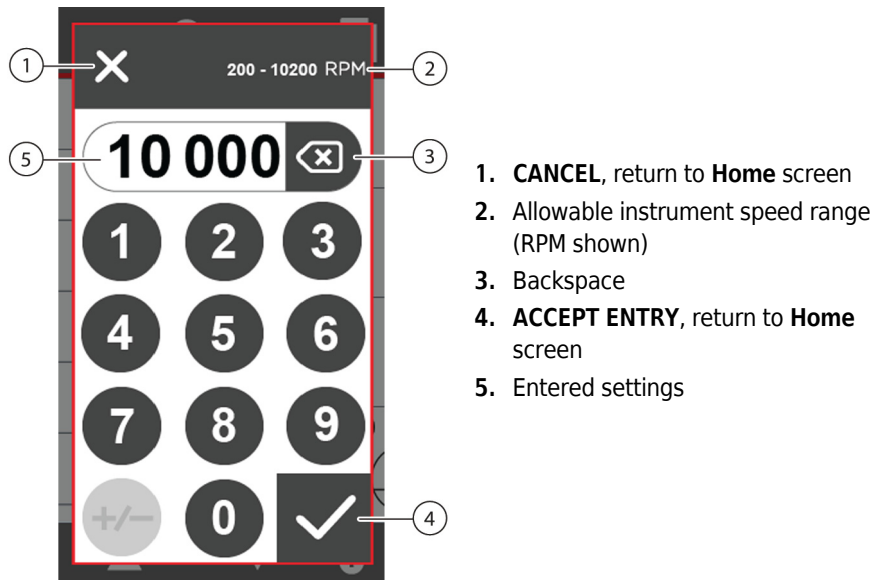



a. Enter the desired **Speed** or **RCF**.

b. Select **ACCEPT ENTRY**  to accept the speed or RCF setting.



OR select **CANCEL** .

Radius

The **Radius** setting  is only applicable when the **Speed** is set to **RCF Mode** . Enter a radius within the minimum and maximum radius of the rotor and accessories in use. See *JS-4.750 Swinging-Bucket Rotor Instructions For Use (B80289)* or *JA-10.100 Fixed-Angle Rotor Instructions For Use (B80290)* for RCF and Radius settings.

NOTE Radius is dependent on rotor specifications, respective buckets and adapters.

To Set the Radius:

- 1 Select **RCF mode** . The **SET RADIUS** button becomes active.
 - 2 Select the **SET RADIUS**  button.
 - 3 Enter the maximum radius of the tube/adaptor to be used. Refer to the appropriate rotor manual for R_{max} values for all supported adapters.
-



Time

The **Time** setting can be set to the **Time Mode**  for a timed run or to the **Hold Mode**  for a continuous run.

In a **Timed** run, the run automatically terminates when the set time reaches zero, and deceleration begins at the selected rate. An audible signal will sound when the rotor has stopped.

In a **Hold** (continuous) run, the run will continue until manually stopped by the user. The maximum duration of a **Hold** Run is 99 hours and 59 minutes. The time display begins counting down when the rotor starts to spin. The elapsed time is displayed and the run continues until **STOP** is pressed.

To Set the Run Time:

- 1 Select  and  to toggle between the **Time** and the **Hold** mode.

2 Select the **TIME** display (Figure 2.4). The **Time** setting screen opens.

Figure 2.4 Time Display

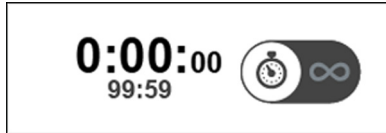

a. Use the keypad to enter the run time (Figure 2.5).

Figure 2.5 Time Keypad

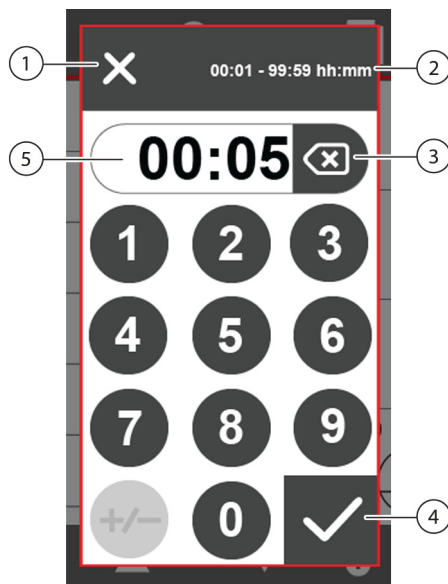

- 1. **CANCEL**, return to **Home** screen
- 2. Allowable time range
- 3. **BACKSPACE**
- 4. **ACCEPT ENTRY**, return to **Home** screen
- 5. Entered settings

b. Select **ACCEPT ENTRY**  to accept the time setting.

OR select **CANCEL** .

Temperature (J-15R only)

The **Temperature** setting can be set to cool the chamber to a desired temperature. Run temperature can be set from -10 to $+40^{\circ}\text{C}$. If no value is entered, the centrifuge selects the last entered temperature.

To pre-cool the rotor chamber, run a 30 minute cycle at the required temperature using an empty rotor, and the speed set at 2000 rpm.

NOTE For runs with temperatures cooler than ambient room temperature, refrigerate the rotor and pre-cool the chamber beforehand for fast equilibration.

NOTE To reach temperatures above ambient, the centrifuge is dependent on the frictional heat generated inside the chamber during operation. At low run speeds or low ambient temperatures, the centrifuge may not be able to achieve some higher temperatures.

To Set the Run Temperature:

- 1 Select the **TEMPERATURE** display (Figure 2.6). The **Temperature** setting screen opens.

Figure 2.6 Temperature Display



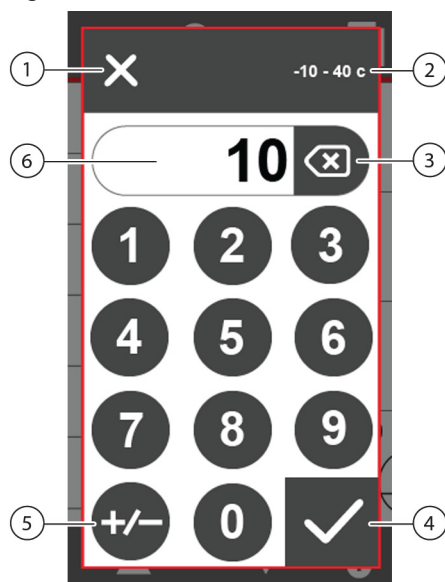

- 2 Use the keypad to enter the required run temperature. The available range is shown at the top of the screen (Figure 2.7)

Figure 2.7 Temperature Keypad



1. **CANCEL**, return to **Home** screen
2. Allowable temperature range
3. Backspace
4. **ACCEPT ENTRY**, return to **Home** screen
5. Change value to above or below zero
6. Entered setting

- a. To enter a temperature below 0°C, select .
 - b. Select **ACCEPT ENTRY**  to accept the temperature setting. If the entered temperature is outside the valid temperature range, the **Accept Entry** button is disabled. Enter a valid temperature.
- OR select **CANCEL** . The **Home** screen appears.

Acceleration/Deceleration

Ten acceleration rates and eleven deceleration rates are available to protect the gradient and sample-to-gradient interface. Select rates depending on the type of run you are performing. For pelleting runs, where sample mixing is not a concern, maximum acceleration and deceleration can be used. If running delicate gradients, a lower setting may be needed. Acceleration and deceleration rates are listed in [Table 2.1](#). If no rate is selected, the centrifuge automatically uses the acceleration and deceleration rates from the previous run.

To Set the Acceleration and Deceleration Rates:



- 1 In the **Home** screen, select **ACCELERATION/DECELERATION** . The **Acceleration/Deceleration** screen opens ([Figure 2.8](#)).

Figure 2.8 Acceleration/Deceleration Settings Screen

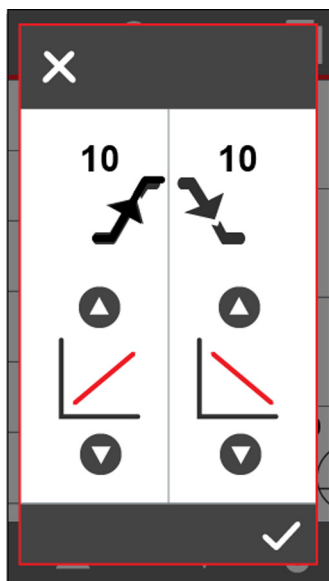

2 Use the up and down arrows   to enter the selected acceleration and deceleration rate numbers. The red lines change their slope to indicate the setting. See (Table 2.1) for the Acceleration and Deceleration rates.

- Acceleration settings: 1 (Slow) through 10 (Maximum).
- Deceleration settings: 0 (no brake) through 10 (Maximum).

Table 2.1 Acceleration and Deceleration Rates (in Minutes: Seconds) to and from Maximum Speed^a

Rate	JS-4.750		JS-4.750 μ		JA-10.100	
	(4750 RPM)		(4450 RPM)		(10,200 RPM)	
	Accel	Decel	Accel	Decel	Accel	Decel
10 (MAX)	1:40	1:05	1:20	1:00	0:45	0:40
9	1:55	1:25	1:40	1:20	1:00	1:00
8	2:20	1:50	2:05	1:05	1:20	1:25
7	2:40	2:15	2:25	2:10	1:45	1:50
6	3:00	2:50	2:50	2:30	2:00	2:10
5	3:20	3:00	3:10	2:55	2:20	2:30
4	3:40	3:20	3:30	3:20	2:45	2:55
3	4:00	3:45	3:55	3:40	3:10	3:20
2	4:25	4:15	4:25	4:10	3:25	3:40
1 (SLOW)	4:45	4:40	4:55	4:35	3:45	4:10
0 (no brake)	N/A	27:30	N/A	26:00	N/A	32:45

a. Times shown are with the rotor fully loaded in the Avanti J-15R. (Times are approximate; actual times will vary depending on the rotor in use, the rotor load, and run speed.)

3 Select **ACCEPT ENTRY**  to accept the **Acceleration/Deceleration** settings.

OR select **CANCEL** .

Start

Select the **START**  key initiate a run with the displayed settings.

Pulse Function

NOTE The **Time** and **Accel/Decel** settings are overridden by the **Pulse** function.

The **Pulse** function eliminates the need to press the **START** and **STOP** keys for short duration runs.

Press and hold the **START**  key. The rotor accelerates at maximum rate to the set speed and continues to spin as long as the **START** key remains pressed. The elapsed time is displayed in minutes and seconds.

When the **START** key is released, the time stops accumulating and the rotor decelerates to 0 RPM, using maximum deceleration.

The centrifuge memory retains the parameters of the last run performed before the **Pulse** function was activated. At the end of a **Pulse** run, after the centrifuge door is opened and closed, the previous run parameters are displayed.

Programmed Run

The instrument's internal memory can store up to 99 programs, which can be recalled by selecting the program number in the **Program Library**. Programs can be protected with a PIN number to prevent them from being changed. Saved programs are retained in memory even if the power is turned off.

Figure 2.9 Program Library

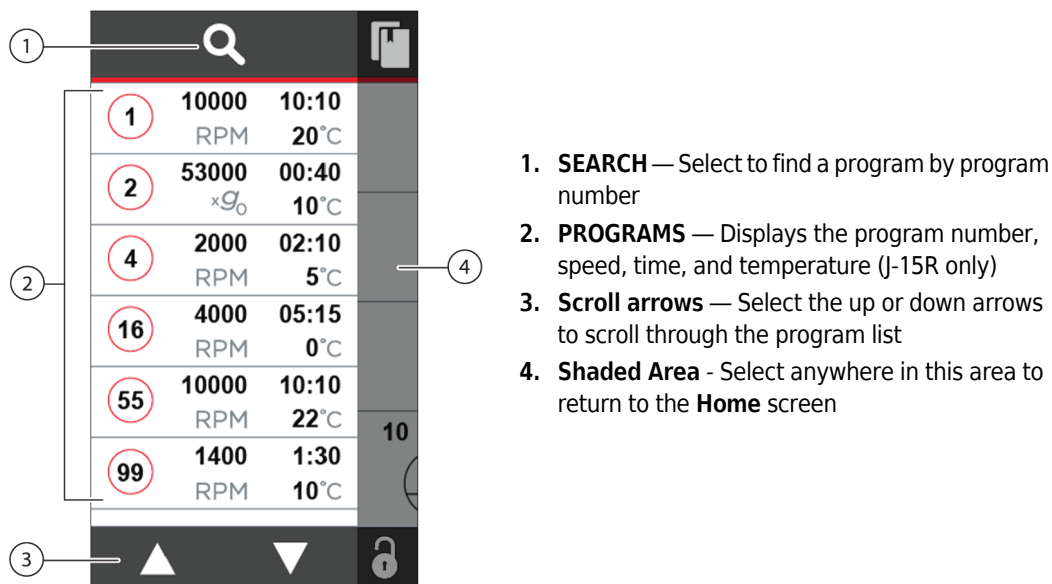

1 Turn the power switch on (I).



2 Press **OPEN DOOR**  to open the chamber door.

3 Install the rotor according to the applicable rotor manual (refer to *JA-10.100 Fixed-Angle Rotor Instructions For Use* (B80290) or *JS-4.750 Swinging-Bucket Rotor Instructions For Use* (B80289)).

NOTE Before installing the rotor, ensure the drive hub is sufficiently lubricated. See [CHAPTER 4, Care and Maintenance](#) for instructions.

4 Select the desired program.

a. Select **LIBRARY** . The **Program Library** screen opens ([Figure 2.9](#)).

b. Select the program number. Use the up and down arrows   to scroll to the desired program, or select **SEARCH**  and enter the program number.

c. Select the program.

5 Close the chamber door. When the latches engage, the **START** symbol  appears.

Create a New Program



- 1 On the **Home** screen, select **NEW PROGRAM** . The program settings screen opens (Figure 2.10) with the current run settings.

Figure 2.10 Program Settings Screen





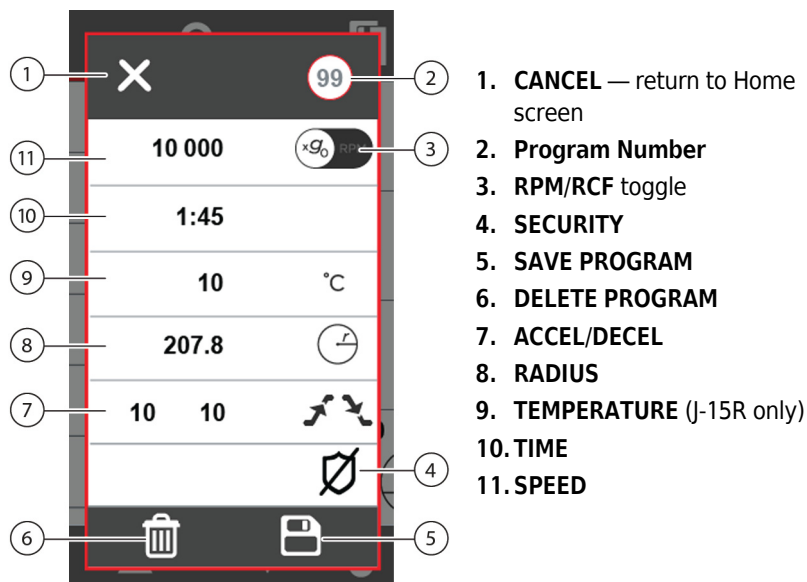

- 2 Optionally, select the program number (Figure 2.10) and enter a new program number. If a new number is not entered, the new program number will default to the next chronological number in the program list.
 - a. Select **ACCEPT ENTRY** .







- 3 Select the setting(s) to be edited. (Figure 2.10). Procedures for entering settings for programs are the same as those described in *Manual Run*. Optionally, edit run parameters (**SPEED, TIME, TEMPERATURE, ACCEL/DECEL**).

- 4 Select **ACCEPT ENTRY**  after each setting has been entered.

NOTE If an unacceptable parameter value is entered, **ACCEPT ENTRY**  is disabled and the input is cleared. Enter a valid parameter value.

-
- 5 The program can be protected to prevent it from being changed or deleted. When **Security** is added to a program, a four digit security PIN number (see [Setting a Security PIN Number](#)) or the administrator PIN number (see [CHAPTER 3, Troubleshooting Chart](#)) must be entered before changing or deleting the program.
- To add a security PIN number to the program, refer to [Setting a Security PIN Number](#).
 - If security protection is not desired, continue to step 6.
-
- 6 Select **SAVE** . The program is saved into the program library.
-
- 7 Select the program to go to the **Home** screen. Select **START**  to start the run.
-
- 8 Wait for the run to end, or end the run by pressing **STOP** .
-
- 9 When the rotor stops, a tone sounds. Select **OPEN DOOR**  to open the chamber door. Lift the door to access the rotor.
-

Use an Existing Program



-
- 1 Select **LIBRARY** . The **Program Library** screen opens ([Figure 2.9](#)).
-
- 2 Select the program number. Use the up and down arrows   to scroll to the desired program,
- OR select **SEARCH**  and enter the program number.
-
- 3 Select the desired program. The **Home** screen appears.
-
- 4 Check that all parameters are correct and that the door is closed. Select **START** .
-
- 5 Wait for the run to end, or end the run by pressing **STOP** .
-

- 6 When the rotor stops, a tone sounds. Select **OPEN DOOR**  to open the chamber door; lift the door to access the rotor.

Edit an Existing Program

Existing programs can be edited.

NOTE If the program is secured by a PIN number, the correct PIN number (see [Setting a Security PIN Number](#)) or the administrator PIN number (see [CHAPTER 3, Troubleshooting Chart](#)) must be entered to change the program prior to saving.

- 1 Select **LIBRARY** . The **Program Library** screen opens ([Figure 2.9](#)).
- 2 If the desired program is not visible, use the up and down arrows   to scroll to the desired program,



OR select **SEARCH**  and enter the program number.
- 3 Select and hold the program to be edited. The **Program Settings** screen opens ([Figure 2.11](#)).



Figure 2.11 Program Settings Screen

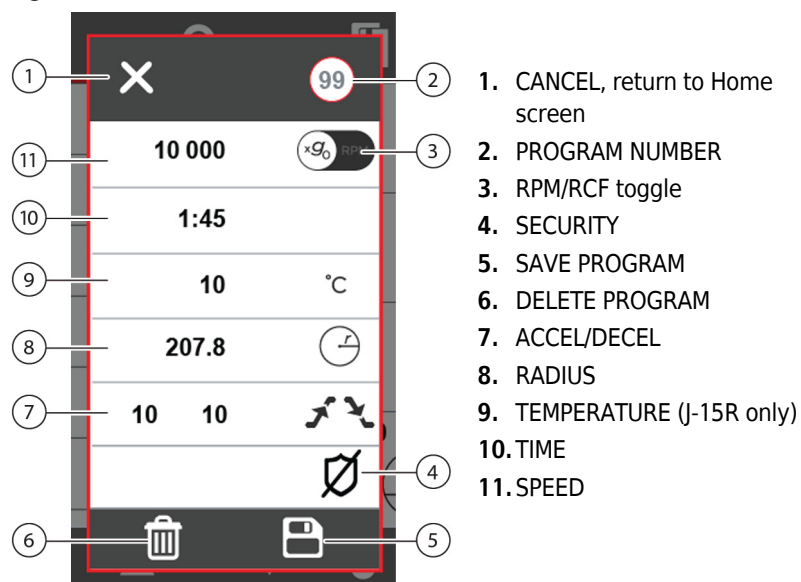

-
- 4 Select the setting to be edited. Procedures for entering settings for programs are the same as those described in [Manual Run](#).
 - a. Enter run parameters (**SPEED**, **TIME**, **TEMPERATURE**, **ACCEL/DECEL**).
 - b. Select **ACCEPT ENTRY**  after each setting has been entered.



NOTE If an unacceptable parameter value is entered, **ACCEPT ENTRY**  is disabled and the input is cleared. Enter a valid parameter value.

 - 5 Optionally, add a security PIN number to the program (refer to [Setting a Security PIN Number](#)).

 - 6 Select **SAVE**  to save the program, or select **CANCEL**  to return to the previous screen without saving the program.
-

Delete a Program

-
- 1 Select **LIBRARY** . The **Program Library** screen opens ([Figure 2.9](#)).

 - 2 If needed, use the up and down arrows   to scroll to the program to be deleted,
OR select **SEARCH**  and enter a program number.

 - 3 Select and hold the program to be deleted. The **Program Setting** screen opens ([Figure 2.10](#)).

 - 4 Select **DELETE** .
- NOTE** If the program is secured by a PIN number, the correct PIN number or the administrator PIN number (see [CHAPTER 3, Troubleshooting Chart](#)) must be entered to delete the program.



- 5 A confirmation screen appears (Figure 2.12). Select **DELETE**  to delete the program.
OR select **CANCEL**  to return to the previous screen.

Figure 2.12 Delete Program Confirmation Screen



- 6 Select the shaded area in the program library screen to return to the **Home** screen.

Setting a Security PIN Number

A security PIN number can be added to a program to prevent it from being edited or deleted.

To Add a Security PIN Number:

- 1 Select **SECURITY** . The **Security Pin Entry** screen opens (Figure 2.13). The **Security Pin Entry Screen** requires that a security PIN be entered twice to confirm the security number.

Figure 2.13 Security Pin Entry Screen





1. The number for each instance of the security code entry flashes.

- 2 The number 1 at the top flashes. Use the keypad to enter a four digit security PIN number.

- Select **BACKSPACE**  to erase an entry, if needed.

- 3 When the four digit security PIN number is entered, **ACCEPT ENTRY**  is enabled. Select it to confirm the PIN entry. The number 1 turns solid green. The number 2 at the top flashes.

- 4 Use the keypad to re-enter the four digit security PIN number.

- 5 Select **ACCEPT ENTRY** . The security icon for the program changes to **SECURE** .

OR select **CANCEL**  to cancel the addition of a security PIN number.

Menu Screen

Figure 2.14 Menu Screen

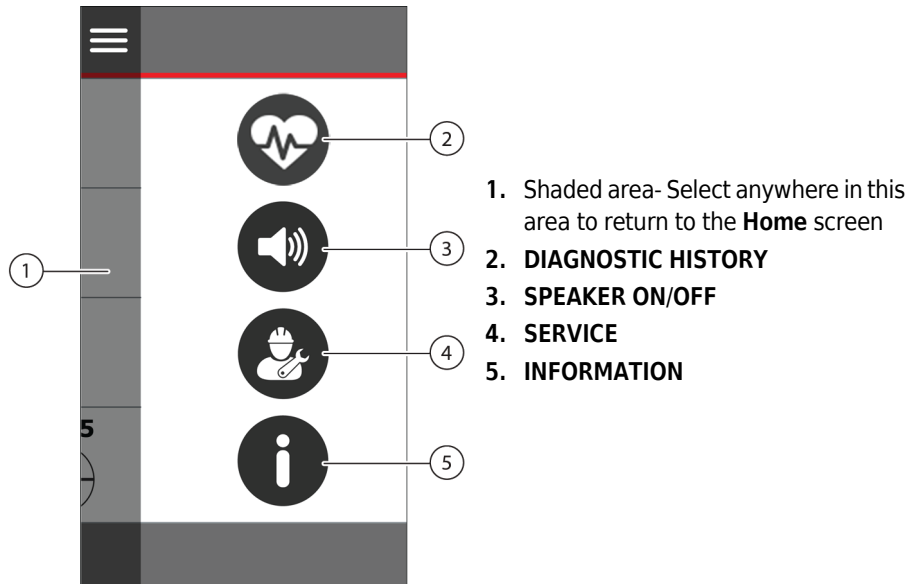

Diagnostic Messages



When an error occurs, an error message appears on the **Home** screen (Figure 2.15). The message includes a message code (Figure 2.15). The state of the instrument at the time of the error is saved in the **Diagnostic History**.

The color of the error field provides information about the status of the error:

- **Orange field** – the condition is cleared, but the condition has not been acknowledged by the user.
- **Red field** – the condition has not been cleared.

Figure 2.15 Diagnostic Messages

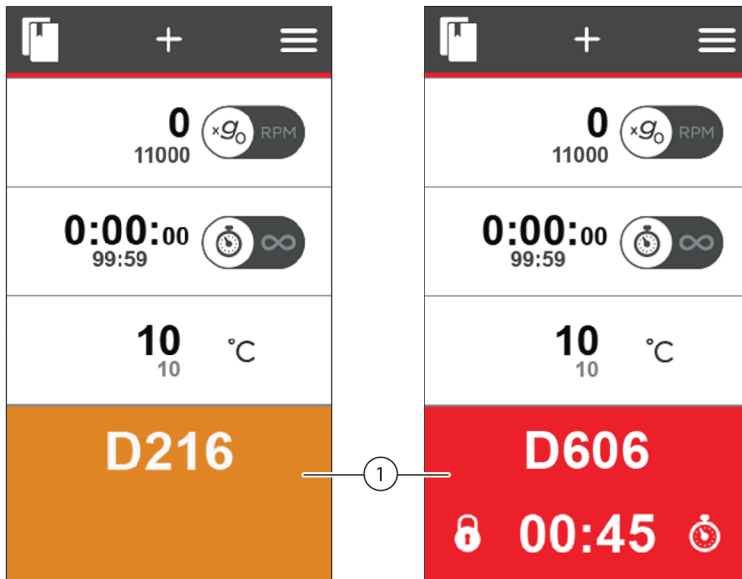

1. Diagnostic Messages

Select the error message on the **Home** page to bring up the **diagnostics list** (Figure 2.16) which allows the user to acknowledge the diagnostic.

Figure 2.16 Diagnostics List

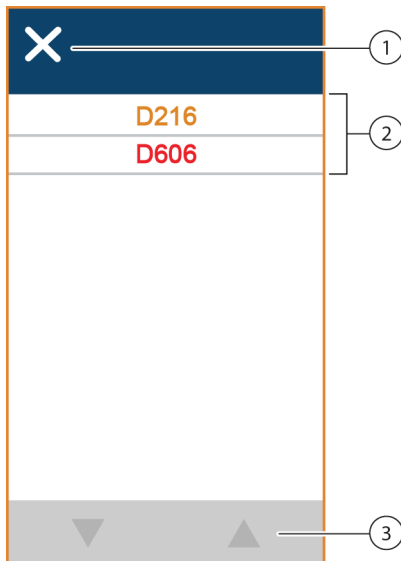

1. Select to close the diagnostics list
2. Select a code to acknowledge the message. Orange text shows that the condition has been cleared. Red text shows that the condition has not been cleared.
3. If there are more diagnostic messages than can fit on the screen, use the up and down arrows to scroll through the messages.



To view a list of the most recent diagnostic codes, select **MENU**  > **DIAGNOSTICS** . The **Diagnostic History** opens ([Figure 2.17](#)).

Figure 2.17 Diagnostic History



1.D216	11.D202
2.D215	12.D216
3.D216	13.D202
4.D216	14.D203
5.D202	15.D202
6.D203	16.D216
7.D202	17.D202
8.D216	18.D203
9.D202	19.D202
10.D203	20.D216

- Shaded Area** — Select anywhere in this area to return to the **Menu** screen.
- Diagnostic messages** — Select to view the Run Settings and Run Conditions of the device at the time of the error.

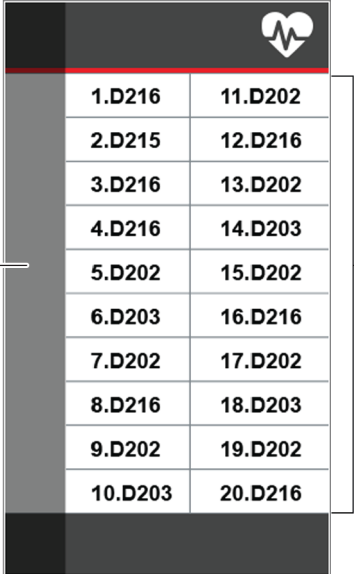

The **Diagnostic History** screen displays the most recent diagnostic message codes. Select a message code for additional information about the state of the centrifuge at the time of the error. The **Diagnostics** screen opens.

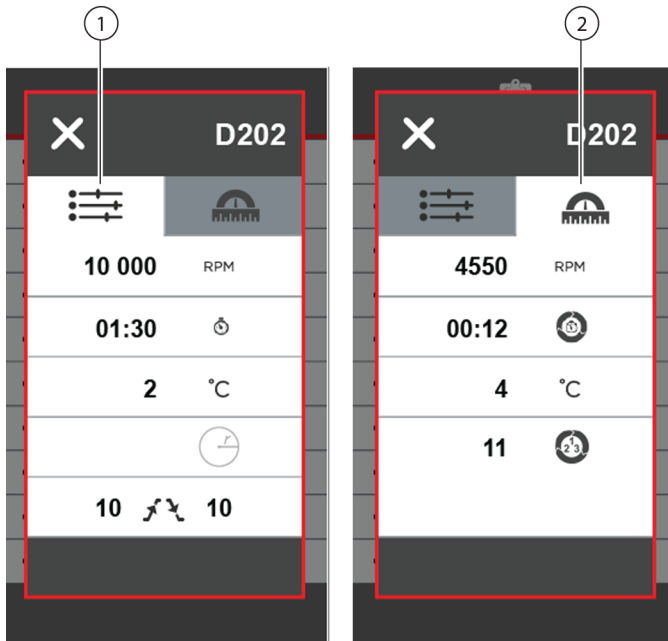
Figure 2.18 Diagnostics Screen — Settings and Conditions



1. Run Settings
2. Run Conditions

Two tabs provide specific information about the state of the instrument at the time of the error (Figure 2.18).

- Select **RUN SETTINGS**  to see the settings at the time of the error.
- Select **RUN CONDITIONS**  to see the state of the instrument at the time of the error.

Disable/Enable the Audible Tones



Audible tones (beeps) are provided for the following events:

- Power up initialization
- Run start
- Run stop
- Key click
- Diagnostic or alert

The audible tones may be turned on and off. The rotor must be at a complete stop to enable or disable the tones.

NOTE The audible tone for **Diagnostic or Alert** cannot be disabled.

To Disable or Enable Audible Tones:

1 Select **MENU** .

2 To disable audible tones, select **SOUND ON** . The icon changes to **SOUND OFF** .

Or, to enable audible tones, press the **SOUND OFF** . The icon changes to **SOUND ON** .

Service



This is for Beckman Coulter Service personnel only.

Information



Select the Information icon to see an information screen with the instrument information (Figure 2.19).

Figure 2.19 Information Screen

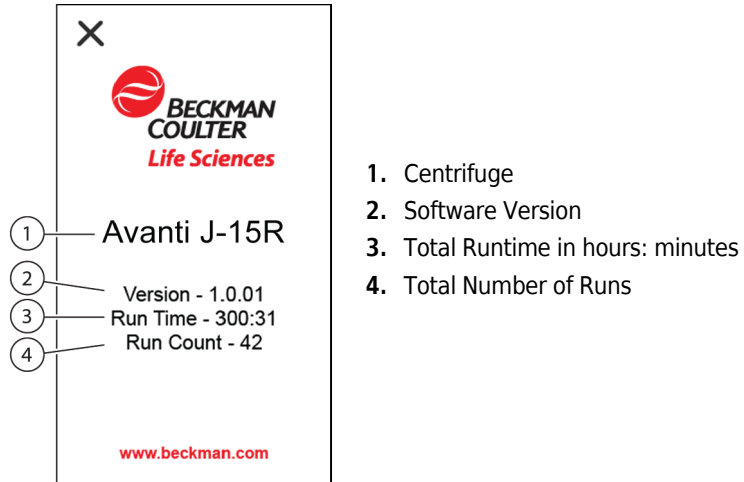

Introduction

This section lists possible malfunctions, together with probable causes and corrective actions. Maintenance procedures are given in [CHAPTER 4, Care and Maintenance](#). For any problems not covered here, [contact us](#).

NOTE It is your responsibility to decontaminate the instrument, as well as any rotors and/or accessories, before requesting service by Beckman Coulter Field Service.

Diagnostics/User Messages Chart

Refer to [Table 3.1](#) to determine the nature of the condition and any recommended actions. If a problem persists after you have performed the recommended action, [contact us](#). To help the field service representative diagnose and correct the problem, gather as much information about the situation as you can, including:

- the diagnostic number and message,
- the operating situation when the diagnostic condition occurred (such as rotor in use, speed, or load type), and
- any unusual environmental and/or operating conditions (such as ambient temperature or voltage fluctuations).

Table 3.1 Diagnostics/User Messages Chart

Message	Definition/Result	Recommended Action
A200 - Power Supply	AC power loss during run, rotor stopped.	<ul style="list-style-type: none"> • Confirm that AC power cord is connected securely. • Confirm that AC line voltage and frequency are within normal operating range. • Check AC outlet. • Refer to building maintenance for frequent AC line interruptions. • If the problem persists, contact us.
A201 - Power Supply	AC power loss during run, rotor still spinning. Rotor coasts to a stop. User may restart run.	<ul style="list-style-type: none"> • Confirm that AC power cord is connected securely. • Confirm that AC line voltage and frequency are within normal operating range. • Check AC outlet. • Refer to building maintenance for frequent AC line interruptions. • If the problem persists, contact us.
A301 - Speed	Set Speed Adjusted. Set Speed or Effective Set Speed is out of range for the rotor. Set Speed or Set RCF is adjusted.	Confirm Set Speed (or Set RCF) is correct.
A306 - Speed	Set Radius Adjusted. The set radius is out of range for the detected rotor. Set radius is adjusted to Rmax for the detected rotor.	Confirm Set Radius is correct.
A700 - Imbalance	Rotor imbalance detected. Rotor brakes to a stop per profile.	<ul style="list-style-type: none"> • Make sure the rotor is installed properly. • Ensure rotor load is balanced. • Ensure the pivot pins and bucket pin pockets are clean. • Ensure the bucket pin pockets are lubricated. • If the problem persists, contact us.
D113 - Display Error	Software error. Rotor brakes to a stop per profile.	If the problem persists, contact us .

Table 3.1 Diagnostics/User Messages Chart (*Continued*)

Message	Definition/Result	Recommended Action
D115 - Control	Software Error Rotor coasts to a stop. Door remains locked for 45 minutes.	Contact us
D121 - Control	Software Error Rotor coasts to a stop. Door remains locked for 45 minutes.	Contact us
D203 - Power Supply	Power Supply Rotor coasts to a stop.	If the problem persists, contact us .
D211 - Power Supply	Power Supply Rotor coasts to a stop.	Contact us
D213 - Power Supply	Power Supply Rotor coasts to a stop.	Contact us
D214 - Power Supply	Power Supply Rotor coasts to a stop.	Contact us
D216 - Power Supply	AC Power Out of Range Rotor coasts to a stop.	<ul style="list-style-type: none"> • Confirm that AC power cord is connected securely. • Confirm that AC line voltage and frequency are within normal operating range. • Check AC outlet. • Refer to building maintenance for frequent AC line interruptions. • If the problem persists, contact us.
D217 - Power Supply	AC Power Out of Range Rotor coasts to a stop.	<ul style="list-style-type: none"> • Confirm that AC power cord is connected securely. • Confirm that AC line voltage and frequency are within normal operating range. • Check AC outlet. • Refer to building maintenance for frequent AC line interruptions. • If the problem persists, contact us.
D300 - Drive	Rotor Speed Rotor coasts to a stop.	Contact us
D304 - Drive	Rotor Speed Rotor coasts to a stop. Door remains locked for 45 minutes.	Contact us

Table 3.1 Diagnostics/User Messages Chart (*Continued*)

Message	Definition/Result	Recommended Action
D307 - Drive	Rotor ID Rotor brakes to a stop per profile.	Contact us
D308 - Drive	Unrecognized Rotor Rotor brakes to a stop per profile.	Contact us
D309 - Drive	Rotor Speed Rotor brakes to a stop per profile.	<ul style="list-style-type: none"> • Confirm that the rotor is tied down. • If the problem persists, contact us.
D503 - Temp	Temperature Rotor brakes to a stop per profile.	Contact us
D504 - Temp	Temperature Rotor brakes to a stop per profile.	Contact us
D505 - Temp	Temperature Rotor brakes to a stop per profile.	<ul style="list-style-type: none"> • Confirm adequate clearance around instrument. Confirm ambient temperature and humidity are within limits. • If the problem persists, contact us.
D510 - Temp (J-15R only)	Temperature Control Rotor brakes to a stop per profile.	<ul style="list-style-type: none"> • Pre-cool rotor chamber and rotor before running at low temperatures. • Confirm adequate clearance around instrument. • Confirm ambient temperature and humidity are within limits. • If the problem persists, contact us.
D515 - Temp (J-15R only)	Temperature Control Rotor brakes to a stop per profile.	Contact us
D600 - Drive	Drive Performance Rotor coasts to a stop.	Contact us
D601 - Drive	Drive Performance Rotor coasts to a stop.	Contact us
D602 - Drive	Drive Temperature Rotor coasts to a stop.	Contact us

Table 3.1 Diagnostics/User Messages Chart (*Continued*)

Message	Definition/Result	Recommended Action
D605 - Drive	Drive Performance Rotor coasts to a stop.	Contact us
D606 - Drive	Drive Performance Rotor coasts to a stop.	<ul style="list-style-type: none"> • Confirm the rotor is tied down. • If the problem persists, contact us.
D607 - Drive	Drive Performance Rotor brakes to a stop per profile. Door remains locked for 2 minutes.	<ul style="list-style-type: none"> • Confirm the drive shaft rotates when spun by hand. • Confirm that a rotor is installed in the chamber and the rotor is tied down. • If the problem persists, contact us.
D608 - Drive	Drive Performance Rotor coasts to a stop. Door remains locked for 45 minutes.	Contact us
D701 - Drive	Imbalance Detector Rotor brakes to a stop per profile.	Contact us
D804 - Door	Door Latch Rotor brakes to a stop at maximum rate.	<ul style="list-style-type: none"> • Confirm that the door is fully closed. • If the problem persists, contact us.
D806 - Door	Door Latch Rotor brakes to a stop at maximum rate.	<ul style="list-style-type: none"> • Confirm that the door is fully closed. • If the problem persists, contact us.
D808 - Door	Door Latch	<ul style="list-style-type: none"> • Check for door obstructions. • If the problem persists, contact us.

Other Possible Problems

Operating problems that may not be indicated by diagnostic messages are described in [Table 3.2](#), along with probable causes, listed in the probable order of occurrence, and corrective actions. Perform the recommended corrective action in sequence, as listed. If you are unable to correct the problem, [contact us](#).

Table 3.2 Troubleshooting Chart

Problem	Problem/Result	Recommended Action
Rotor cannot achieve set speed	Electrical failure	Make sure the power cord is securely connected; contact us .
	Motor failure	Contact us .
Door will not open	Rotor spinning	Wait until the rotor stops.
	Power not on	Plug in the power cord; turn power on.
	Source power failure	See Retrieving Your Sample in Case of a Power Failure , below.
Displays are blank	Power not on	Plug in the power cord; turn power on.
	Electrical failure	<ul style="list-style-type: none"> • Make sure the power cord is securely connected. • If the problem persists, contact us.
Program security PIN number is not known	Unable to edit or delete a program with security setting	Enter the Administrator PIN number in place of the security PIN number to edit or delete the program: 2366
Chamber does not reach selected temperature	Centrifuge cannot maintain selected temperature for rotor in use at speed selected	<ul style="list-style-type: none"> • Pre-cool or pre-warm rotors before running at low or high temperatures. • Precool rotor chamber by running a 30-minute cycle at the required temperature with the speed set at 2000 rpm. • Make sure the air intake vent is clear. • If using multiwell-plates for runs exceeding 2 hours in a warm and/or humid environment, speed reduction may be required to maintain low sample temperature.
Chamber icing	Excess humidity in chamber	Wipe out moisture from the chamber and the chamber gasket before each run.
	Condensation build-up between runs	<ul style="list-style-type: none"> • Leave door open between runs. • Set temperature to a setting higher than ambient temperature. • Turn centrifuge power off.

Retrieving Your Sample in Case of a Power Failure

WARNING

Risk of personal injury. Never attempt to override the door interlock system while the rotor is spinning. Wait for the rotor to come to a complete stop before attempting to open the door.

If facility power fails, the run will have to be restarted when the power is restored. In the event of an extended power failure, it may be necessary to trip the door-locking mechanism manually to [CHAPTER 3, Retrieving Your Sample in Case of a Power Failure](#) remove the rotor and retrieve your sample.

To retrieve a sample during a power failure:

- 1 Turn the power off and disconnect the power cord from the main power source.

NOTE Look through the view port to make sure the rotor tie-down handle is not spinning. Confirm there is no sound or vibration coming from the centrifuge.

- 2 Locate the release cords underneath the bottom center of the centrifuge ([Figure 3.1](#)).

Figure 3.1 Door Latch Override

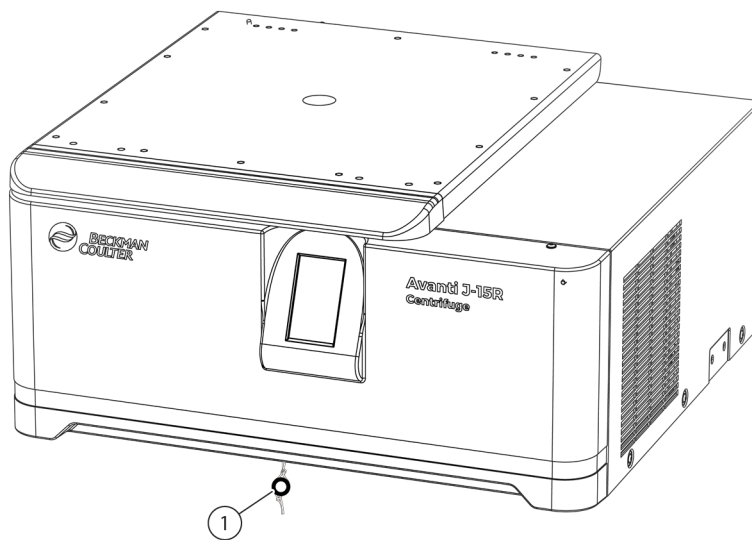

1. Release cords

-
- 3 Pull on the cords, or insert a screwdriver through the two cords, and pull to release the latch and open the door.



WARNING

Risk of personal injury. If the door is open and the rotor is still spinning, close the door and wait until it stops before attempting to access it. Never attempt to slow or stop the rotor by hand.

Introduction

This section contains care and maintenance procedures that should be performed regularly. For maintenance not covered in this manual, [contact us](#) for assistance. User messages and recommended actions are discussed in [CHAPTER 3, Troubleshooting](#).

NOTE It is your responsibility to decontaminate the centrifuge, as well as any rotors and/or accessories, before requesting service by Beckman Coulter Field Service.

Instrument Care



Risk of personal injury. Any maintenance procedure requiring removal of a panel exposes the operator to the possibility of electrical shock and/or mechanical injury. Turn the power off and disconnect the instrument from the main power source and refer such maintenance to service personnel.

Maintenance

Perform the following procedures regularly to ensure continued performance and long service life of the centrifuge.

- Lubricate the drive shaft with Spinkote at least once a month, and after each cleaning.
- Inspect the centrifuge chamber for accumulations of sample, dust, or glass particles from broken sample tubes.

Clean as required (see [Cleaning](#)).

- Check the air intake and exhaust for obstructions. Keep vents clear and clean.
- Wipe condensation out of the rotor chamber between runs with a sponge or clean cloth to prevent chamber icing.
- **J-15R only**- If chamber icing occurs, defrost the system and wipe moisture out of the chamber before use.

To defrost the system, set the temperature to 30°C for 20 minutes, and run the centrifuge with a rotor installed. (These are suggested settings which may be adjusted as appropriate for your laboratory conditions.)

NOTE Before using any cleaning or decontamination methods other than those recommended by the manufacturer, users should check with the manufacturer that the proposed method will not damage the equipment.

Cleaning

 **WARNING**

Risk of personal injury or contamination. Prior to cleaning equipment that has been exposed to hazardous material, contact the appropriate chemical and biological safety personnel. Always use the appropriate Personal Protective Equipment (PPE) when cleaning the centrifuge.

 **WARNING**

Risk of personal injury. If a glass tubes breaks, glass fragments may escape the bucket or rotor. Be careful when examining or cleaning the chamber and chamber gasket, as sharp glass fragments may be embedded in their surfaces. Always use the appropriate Personal Protective Equipment (PPE) when cleaning the centrifuge.

Clean the centrifuge frequently. Always clean up spills when they occur to prevent corrosives or contaminants from drying on component surfaces.

-
- 1 To prevent accumulations of sample, dust, and/or glass particles from broken sample tubes, keep the chamber clean and dry by frequent wiping with a cloth or paper towel.
 - a. For thorough cleaning, wash the chamber using a mild detergent such as Solution 555 (PN 339555).
 - b. Dilute the detergent with water (10 parts water to 1 part detergent).
 - c. Rinse thoroughly and dry completely.

 - 2 Wash the bowl using a mild detergent such as diluted Solution 555.
 - a. Rinse thoroughly and dry completely.
 - b. If a cleaning solution other than Solution 555 is used, consult *Chemical Resistances* (publication IN-175) or contact the cleaning-solution vendor to verify that the solution will not damage the centrifuge.

 - 3 Clean the centrifuge exterior surfaces by wiping with a cloth dampened with Solution 555. Dilute the detergent with water (10 parts water to 1 part detergent).

IMPORTANT Do not use acetone.

-
- 4 Remove the rotor from the centrifuge and clean the drive shaft, shaft cavity, threads, and the tie-down screw regularly using a mild detergent such as Solution 555 and a soft brush.
 - a. Dilute the detergent with water (10 parts water to 1 part detergent).
 - b. Rinse thoroughly and dry completely.
 - c. Lubricate the drive shaft with Spinkote after cleaning.
-

Tube Breakage



Risk of personal injury. If a glass tube breaks, glass fragments may escape the bucket or rotor. Be careful when examining or cleaning the chamber and chamber gasket, as sharp glass fragments may be embedded in their surfaces. Always use appropriate personal protective equipment (PPE) when cleaning the centrifuge.

-
- 1 If a glass tube breaks, and all the glass is not contained in the bucket or rotor, be sure to thoroughly clean the chamber.
-
- 2 Examine the chamber gasket to make sure that no glass particles are retained in it. Carefully remove any glass particles that may remain.
-
- 3 Carefully wipe away any glass particles that remain in the chamber.
-

Decontamination

If the centrifuge and/or accessories are contaminated with radioactive or pathogenic solutions, perform appropriate decontamination procedures. Refer to *Chemical Resistances* (publication IN-175) to be sure the decontamination method will not damage any part of the instrument.

Sterilization and Disinfection

The centrifuge has a durable powder coat finish. Ethanol (70%) may be used on this surface. See *Chemical Resistances* for chemical compatibilities of centrifuge and accessory materials.

 **WARNING**

Risk of personal injury and equipment damage. Ethanol is a flammability hazard. Vapors from flammable reagents or combustible fluids could enter the centrifuge air system and be ignited by the motor. Do not use Ethanol or other combustible materials near operating centrifuges.

While Beckman Coulter has tested ethanol (70%) and found that it does not damage the centrifuge, no guarantee of sterility or disinfection is expressed or implied. When sterilization or disinfection is a concern, consult your laboratory safety officer regarding proper methods to use.

Circuit Breaker and Fuses

There are no user-replaceable fuses in the centrifuge.

 **CAUTION**

Risk of equipment damage. Repeated attempts to reset the centrifuge circuit breaker can cause substantial damage to electrical and electronic components. Do not repeatedly attempt to reset the centrifuge circuit breaker.

If the centrifuge circuit breaker trips for any reason, the power switch will move to the off (O) position. Reset the circuit breaker by turning the power switch back to the on (I) position. If it trips again immediately, *do not reset it*. [Contact us](#).

Storage and Transport

To ensure that the centrifuge does not get damaged, [contact us](#) for specific instructions and/or assistance in preparing the equipment for transport or long-term storage. Temperature and humidity conditions for storage should meet the environmental requirements described under *Specifications* in [CHAPTER 1](#).

Supply List

Contact us for information about ordering parts and supplies. For your convenience a partial list is given below.

Replacement Parts

Description	Part Number
Anchor Kit	C01992

Supplies

NOTE For SDS information, go to the Beckman Coulter website at www.beckmancoulter.com.

Description	Part Number
Silicone vacuum grease (1 oz)	335148
Solution 555 (1 qt)	339555
Program library record	233679

Introduction

⚠ WARNING

Risk of personal injury or equipment damage. The J-15 centrifuge weighs 93 kg (205 lb). the J-15R centrifuge weighs 120 kg (265 lb). Do not attempt to lift or move it without assistance. Follow your safety officer's instructions regarding lifting heavy objects.

⚠ CAUTION

Risk of personal injury or equipment damage. The intake cover on the ventilated centrifuge is not designed to be used to lift or move the instrument, as it could break or bend. Do not use the intake cover on the ventilated centrifuge to lift or move the centrifuge (see [Figure A.1](#)).

Figure A.1 Ventiladed Instrument Intake Cover

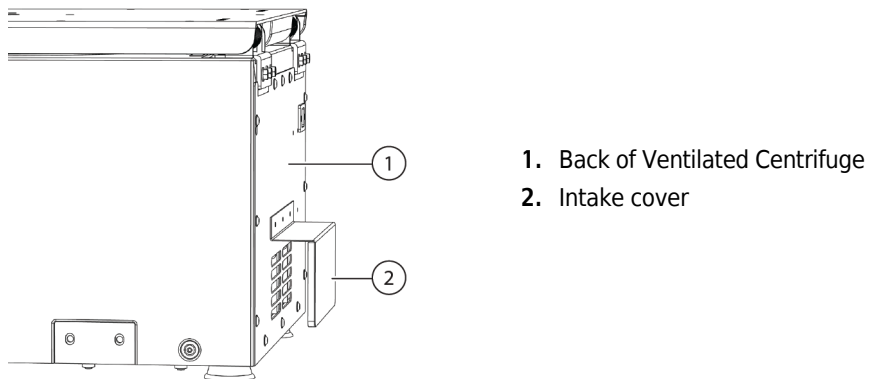

Space and Location Requirements

 **WARNING**

Risk of personal injury or equipment damage. Vapors from flammable reagents or combustible fluids could enter the centrifuge air system and be ignited by the motor. Do not place the centrifuge near areas containing flammable reagents or combustible fluids.

The centrifuge ships in a cardboard box on a wooden pallet. For easy access, remove the top of the box, the foam insert on top of the centrifuge, and then the upper part (sides) of the box and set them aside. Then, *with assistance*, move the centrifuge from the pallet to its final position.

- Position the centrifuge on a level surface, such as a sturdy table or laboratory bench that is able to support the weight of the centrifuge and resist vibration (see [CHAPTER 1, Specifications](#) for weight).
- Make sure that all feet are fully supported on the table.
- Locate the centrifuge away from heat-producing laboratory equipment.
- Locate the centrifuge in an area with sufficient ventilation to allow for sufficient heat dissipation.
- Check that there are adequate clearances at the sides and back of the centrifuge to ensure sufficient air circulation:
 - J-15 Centrifuge: 7.6 cm (3 in.)*
 - J-15R Centrifuge: 7.6 cm (3 in.)
- The centrifuge must have adequate air ventilation to ensure compliance to local requirements for vapors produced during operation.
- Ambient temperatures during operation should not be lower than 10°C (50°F), or higher than 31°C (88°F) for the J-15, and 35°C (95°F) for the J-15R.
- Altitude should not exceed 2000 meters.
- Additional clearance is required on the left side to allow access to the power switch.
- Dimensions for the Avanti J-15 are shown in [Figure A.2](#). Dimensions for the Avanti J-15R are shown in [Figure A.3](#).
- Relative humidity should not exceed 80% (non-condensing).

* When operating the J-15 Centrifuge, maintain a 30 cm (12 in.) clearance envelope around the centrifuge under the following circumstances: 1) Run duration exceeds 60 minutes or 2) Ambient temperature exceeds 25°C.

Securing the Centrifuge

Securing the Centrifuge to a Bench

Avanti J-15 series centrifuges are certified to meet the requirements of the European CE mark. To meet these requirements, the centrifuge can be secured to the bench using the optional anti-rotation kit (PN C01992). This will prevent the centrifuge from moving in the unlikely event of a rotor mishap.

Complete instructions for installing the anti-rotation kit are included with the hardware. The instructions (publication B80291) include a full-size template to be used as a guide for drilling holes in the bench. Refer to this document for installation instructions.

Electrical Requirements



To reduce the risk of electrical shock, the instrument uses a three-wire electrical cord and plug to connect it to earth-ground. Make sure that the matching wall outlet receptacle is properly wired and earth-grounded.

- **Check that the line voltage agrees with the voltage listed on the name-rating plate affixed to the centrifuge.**
- **Never use a three-to-two wire plug adapter.**
- **Never use a two-wire extension cord or a two-wire non-grounding type of multiple-outlet receptacle strip.**

See [CHAPTER 1, Specifications](#) for electrical requirements.

To reduce the risk of electrical shock, this centrifuge comes with a 2.5-m (8-ft) three-wire electrical cord (attached to the power connector at the rear of the instrument) and plug to connect the centrifuge to earth-ground. Power cords are supplied for select geographical areas. In cases where the appropriate power cord is not included, an unterminated power cord is provided. A plug that meets local electrical and safety requirements must be obtained and added to this unterminated power cord. For some models, a country guide is included to indicate the appropriate power cord to use.

- If there is any question about voltage, have a qualified service person measure it under load while the drive is operating.
- To ensure safety, the centrifuge should be wired to a remote emergency switch (preferably outside the room where the centrifuge is housed, or adjacent to the exit from that room) in order to disconnect the centrifuge from the main power source in case of a malfunction.

Test Run

NOTE The centrifuge must be plugged in and the power switch turned to the on position (I) before the door can be opened.

We recommend that you make a test run to ensure that the centrifuge is in proper operating condition following shipment. See [CHAPTER 2, *Operation*](#) for instructions on operating the centrifuge.

Abbreviations

A — Ampere	PN — Part number
Btu — British thermal unit	RCF — Relative centrifugal field
bps — Bits per second	Rmax — Maximum radius
°C — Degrees Celsius or Degrees Centigrade	RPM — Rotations per minute
CE — Conformance European Marking signifying compliance with applicable European directives	SDS — Safety data sheets
cm — Centimeter	V — Volt
dBa — Decibel	Vac — Volts of alternating current
°F — Degrees Fahrenheit	W — Watt
ft — Foot or feet	WEEE — Waste Electrical and Electronic Equipment
g — Grams	
h — Hour	
Hz — Hertz	
ID — Identification	
IEC — International Electrical Commission	
in. — Inches	
ISO — International Organization for Standardization	
IVD — In-Vitro Diagnostic	
kg — Kilograms	
kW — Kilowatt	
L — Liter	
lb — Pound	
LCD — Liquid crystal diode	
m — Meter	
mL — Milliliter	
mm — Millimeter	
n — Number	
NRTL — Nationally Recognized Testing Laboratory	

Symbols

- °C
 - defined, [Abbreviations-1](#)
- °F
 - defined, [Abbreviations-1](#)

A

- acceleration
 - rates, [2-10](#)
 - set, [2-9](#)
- anti-rotation kit, [A-4](#)
- audible tones
 - enable and disable, [2-22](#)

B

- Beckman Coulter Customer Support Center,
 - contacting, [1-1](#)

C

- call center, contact information, [1-1](#)
- capacity, [1-12](#)
- chamber icing, J-15R only, [4-1](#)
- circuit breaker, [4-4](#)
- cleaning, [4-2](#)
- contact information, Beckman Coulter Customer Support Center, [1-1](#)
- control panel, [1-4](#)

D

- deceleration
 - rates, [2-10](#)
 - set, [2-9](#)
- decontamination, [4-3](#)
- defrost J-15R, [4-1](#)
- diagnostics
 - history
 - messages, [2-19](#)
 - screen, [2-21](#)
 - list, [2-20](#)
 - log, [2-21](#)

- messages, [2-19](#)
- screen, [2-22](#)
- user message chart, [3-1](#)
- disinfection, [4-4](#)
- door, [1-3](#)
 - latch override, [3-7](#)
- drive, [1-3](#)

E

- electrical requirements, [A-4](#)
- error message, [1-8, 2-19](#)

H

- Help, Beckman Coulter Customer Support, [1-1](#)
- housing, [1-2](#)

I

- imbalance, [1-8](#)
- installation
 - rotor, [2-4](#)
- installation, centrifuge, [A-1](#)

J

- JA-10.100 Fixed Angle Rotor specifications, [1-12](#)
- JS-4.750 Swinging Bucket Rotor specifications, [1-12](#)

M

- maintenance, [4-1](#)
- manual run, [2-3](#)
- manual updates, [1-iii](#)
- Max RCF, [1-12](#)
- Max RPM, [1-12](#)
- menu screen, [2-19](#)
- Multiwell-plate carriers specifications, [1-12](#)

N

- NRTL

- defined, [Abbreviations-1](#)
- O**
- out of range message
 - temperature, [2-9](#)
- P**
- PN
- defined, [Abbreviations-1](#)
- power failure
- retrieving your sample, [3-7](#)
- power switch, [1-4](#)
- Procedure
- Manual Run, [2-3](#)
 - Programmed Run, [2-11](#)
- program
- create new, [2-13](#)
 - delete, [2-16](#)
 - recall, [2-13](#)
 - use existing, [2-14](#)
- pulse function, [2-11](#)
- R**
- RCF
- defined, [Abbreviations-1](#)
- RCF-Relative Centrifugal Field
- description, [1-12](#)
- release cords, manual door latch override, [3-7](#)
- replacement parts, [4-5](#)
- rotor
- chamber, [1-3](#)
 - installation, [2-2](#)
- rotors, [1-12](#)
- RPM
- defined, [Abbreviations-1](#)
- run parameters set, [2-4](#)
- S**
- safety features, [1-2](#)
- safety notice
- China RoHS Caution Label, [1-xii](#)
 - instrument safety precautions, [1-vi](#)
- sample recovery after power failure, [3-7](#)
- screen
- acceleration and deceleration settings, [2-9](#)
 - delete program, [2-17](#)
 - diagnostics, [2-22](#)
 - diagnostics log, [2-21](#)
 - home, [2-3](#)
 - information, [2-23](#)
 - menu, [2-19](#)
 - program library, [2-11](#)
 - program settings, [2-13](#), [2-15](#)
 - security PIN entry screen, [2-18](#)
 - service, [2-23](#)
 - speed entry, [2-5](#)
 - temperature entry, [2-8](#)
 - time entry, [2-7](#)
- securing centrifuge to a bench, [A-4](#)
- security PIN add, [2-18](#)
- service, contact information, [1-1](#)
- settings
- acceleration, deceleration, [2-9](#)
 - radius, [2-6](#)
 - speed, [2-4](#)
 - temperature (J-15R only), [2-8](#)
 - time, [2-6](#)
- space and location requirements, [A-2](#)
- specifications, [1-10](#)
- speed
- set, [2-4](#)
- Spinkote, [4-1](#), [4-3](#)
- start, [2-10](#)
- sterilization, [4-4](#)
- storage, [4-4](#)
- supplies, [4-5](#)
- support, Beckman Coulter customer, [1-1](#)
- T**
- temperature
- set, [2-8](#)
- Temperature Sensing and Control, [1-3](#)
- time
- set, [2-6](#)
- touch screen, [1-5](#)
- description, [1-5](#)
- transport, [4-4](#)
- troubleshooting, [3-6](#)
- Tube-and-bottle buckets specifications, [1-12](#)
- V**
- V
- defined, [Abbreviations-1](#)

W

W

defined, [Abbreviations-1](#)

WEEE

defined, [Abbreviations-1](#)

Beckman Coulter, Inc.

Avanti J-15 Series Centrifuge Warranty

Subject to the exceptions and upon the conditions specified below and the warranty clause of the Beckman Coulter, Inc. terms and conditions in effect at the time of sale, Beckman Coulter agrees to correct either by repair or, at its election, by replacement, any defects of material or workmanship which develop within one (1) year after delivery of an Avanti J-15 Series centrifuge (the product), to the original buyer by Beckman Coulter or by an authorized representative, provided that investigation and factory inspection by Beckman Coulter discloses that such defect developed under normal and proper use.

Some components and accessories by their nature are not intended to and will not function for as long as one (1) year. A complete list of such components or accessories is maintained at the factory and at each Beckman Coulter District Sales Office. The lists applicable to the products sold hereunder shall be deemed to be part of this warranty. If any such component or accessory fails to give reasonable service for a reasonable period of time, Beckman Coulter will repair or, at its election, replace such component or accessory. What constitutes either reasonable service and a reasonable period of time shall be determined solely by Beckman Coulter.

Replacement

Any product claimed to be defective must, if requested by Beckman Coulter, be returned to the factory, transportation charges prepaid, and will be returned to Buyer with the transportation charges collect unless the product is found to be defective, in which case Beckman Coulter will pay all transportation charges.

Conditions







Beckman Coulter makes no warranty concerning products or accessories not manufactured by it. In the event of failure of any such product or accessory, Beckman Coulter will give reasonable assistance to the Buyer in obtaining from the respective manufacturer whatever adjustment is reasonable in light of the manufacturer's own warranty.

Beckman Coulter shall be released from all obligations under all warranties, either expressed or implied, if the product(s) covered hereby are repaired or modified by persons other than its own authorized service personnel, unless such repair in the sole opinion of Beckman Coulter is minor, or unless such modification is merely the installation of a new Beckman Coulter plug-in component for such product(s).



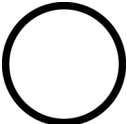

Disclaimer

IT IS EXPRESSLY AGREED THAT THE ABOVE WARRANTY SHALL BE IN LIEU OF ALL WARRANTIES OF FITNESS AND OF THE WARRANTY OF MERCHANTABILITY AND THAT BECKMAN COULTER, INC., SHALL HAVE NO LIABILITY FOR SPECIAL OR CONSEQUENTIAL DAMAGES OF ANY KIND WHATSOEVER ARISING OUT OF THE MANUFACTURE, USE, SALE, HANDLING, REPAIR, MAINTENANCE, OR REPLACEMENT OF THE PRODUCT.

Symbols

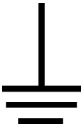
English / Deutsch / Español / Français / Italiano / Português / Русский / 中文 / 日本語 / 한국어	
Symbol	Simbole
Symbol	символ
Simbolo	??
Symbole	??
Simbolo	상징
Title / Titel / Titolo / Titre / Titolo / Titolo / Название / 标题 / タイトル / 제목	
	<p>Dangerous voltage Gefährliche elektrische Spannung Voltaje peligroso Courant haute tension Pericolo: alta tensione</p> <p>Tensão perigosa Опасное напряжение тока 危险电压 危険な電圧 위험한 전압</p>
	<p>Caution, consult accompanying documents Vorsicht, konsultieren Begleitdokumente Atención, consulta documentos adjuntos Attention, consultant des documents d'accompagnement Attenzione, consulta i documenti di accompagnamento</p> <p>Cuidado, ulta documentos adjuntos Внимание, советует с сопроводительными документами 注意, 咨询附属单证 注意, 伴う文書に相談しなさい 주의, 동반 문서를 상담하십시오</p>
	<p>Biohazard Potentiell infektiösem Material Riesgo biológico Risque biologiqu Pericolo biologico</p> <p>Material infeccioso potencial биологической опасности 可能的传染性物 潜在的な感染性物質 전염하는 물자</p>
	<p>On (power) Ein (Netzverbindung) Encendido Marche (mise sous tension) Acceso (sotto tensione)</p> <p>Fora (o poder) На (мощности) 开 (电源) ン (電源) 에 (힘)</p>
	<p>Off (power) Aus (Netzverbindung) Apagado Arrêt (mise sous tension) Spento (fuori tensione)</p> <p>Fora de (poder) С (сила) (电源) ン (電源) 떨어져 (힘)</p>
	<p>Protective earth (ground) Schutzleiteranschluß Puesta a tierra de protección Liaison à la terre Collegamento di protezione a terra</p> <p>Terra de proteção (terra) Защитное заземление (земля) 保护接地 保護アース (接地) 방어적인 지구 (지상)</p>

Symbols

English / Deutsch / Español / Français / Italiano / Português / Русский / 中文 / 日本語 / 한국어		
Symbol	Simbole	
Symbol	символ	
Simbolo	??	
Symbole	??	
Simbolo	상징	
Title / Titel / Título / Titre / Titolo / Titolo / Название / 标题 / タイトル / 제목		
	<p>Earth (ground) Erde (Masse) La tierra (suelo) Terre (sol) Scarica a terra</p>	<p>Terra Земли 接地 アース (接地) 지구 (지상)</p>
	<p>In vitro diagnostic medical device In-vitro-diagnosemedizinisches Gerät Aparato médico de diagnóstico in vitro Appareil médical diagnostique in vitro Apparecchio medico diagnostico in vitro</p>	<p>In vitro dispositivo médico diagnóstico В медицинской службе диагностики vitro 体外诊断医疗设备 生体外の診断医療機器 생체외 진단 의료 기기</p>
	<p>Manufacturer Hersteller Fabricante Fabricant Fabbricante</p>	<p>Fabricante производитель 制造商 ???? ???</p>
	<p>Consult Instructions for Use Konsultieren Sie Anwendungsvorschriften Consulte las instrucciones para el uso Consultez les instructions pour l'usage Consulti le istruzioni per uso</p>	<p>Consulte instruções para o uso Советуйте с инструкциями для пользы 咨询使用说明书 使用説明に相談しなさい 사용 설명을 상담하십시오</p>

Related Documents

Pre-installation Instructions for the Avanti J-15 Series Centrifuges

PN B80285

Avanti J-15 Series Centrifuges Instructions for Use

PN B80287

Avanti J-15 Series Centrifuges Safety Manual

PN B80288

JS-4.750 Swinging-Bucket Rotor Instructions for Use

PN B80289

JA-10.100 Fixed-Angle Rotor Instructions for Use

PN B80290

Instructions for Using the Anti-Rotation Anchoring Kit to Secure the Avanti J-15 Series Benchtop Centrifuges

PN B80291

JS-4.750 Swinging-Bucket Rotor and JA-10.100 Fixed Angle Rotor Safety Manual

PN C01058

Avanti J-15 Series Centrifuge Quick Start Guide

PN C01864

Avanti J-15 Series Centrifuges Cart Instructions for Use

PN C05448

Chemical Resistances for Beckman Coulter Centrifugation Products

PN IN-175

Available in hard copy or electronic pdf by request.

Available at www.beckmancoulter.com

www.beckmancoulter.com

