

Instructions For Use

JS-5.3 Swinging-Bucket Rotor

For Use in Beckman Coulter
Avanti J-26S XP Series,
Avanti J-26 XP Series,
Avanti JXN-26,
and Avanti J-E Centrifuges



PN J-TB-089AH
May 2017



Beckman Coulter, Inc.
250 S. Kraemer Blvd.
Brea, CA 92821 U.S.A.



JS-5.3 Swinging-Bucket Rotor

PN J-TB-089AG (May 2017)

©2017 Beckman Coulter, Inc.

Beckman Coulter, the stylized logo, and the Beckman Coulter product and service marks mentioned herein are trademarks or registered trademarks of Beckman Coulter, Inc. in the United States and other countries.

All other trademarks, service marks, products, or services are trademarks or registered trademarks of their respective holders.

Contact Us

If you have any questions, contact our Customer Support Center.

- Worldwide, find us via our website at www.beckmancoulter.com/customersupport/support
- In the USA and Canada, call us at 1-800-369-0333.
- Outside of the USA and Canada, contact your local Beckman Coulter Representative.

EC REP

Beckman Coulter Eurocenter S.A.
22, rue Juste-Olivier
Case Postale 1044
CH - 1260 Nyon 1, Switzerland
Tel: +41 (0) 22 365 36 11

Safety Notice

Read all product manuals and consult with Beckman Coulter-trained personnel before attempting to use this equipment. Do not attempt to perform any procedure before carefully reading all instructions. Always follow product labeling and manufacturer's recommendations. If in doubt as to how to proceed in any situation, contact your Beckman Coulter Representative.

Alerts for Warning, Caution, Important, and Note

 **WARNING**

WARNING indicates a potentially hazardous situation which, if not avoided, could result in death or serious injury.

 **CAUTION**

CAUTION indicates a potentially hazardous situation, which, if not avoided, may result in minor or moderate injury. It may also be used to alert against unsafe practices.

IMPORTANT IMPORTANT is used for comments that add value to the step or procedure being performed. Following the advice in the Important adds benefit to the performance of a piece of equipment or to a process.

NOTE NOTE is used to call attention to notable information that should be followed during installation, use, or servicing of this equipment.

Safety Information for the JS-5.3 Rotor

This rotor was developed, manufactured, and tested for safety and reliability as part of a Beckman Coulter centrifuge/rotor system. Their safety or reliability cannot be assured if used in a centrifuge not of Beckman Coulter's manufacture or in a Beckman Coulter centrifuge that has been modified without Beckman Coulter's approval.

Handle body fluids with care because they can transmit disease. No known test offers complete assurance that such fluids are free of micro-organisms. Some of the most virulent – Hepatitis (B and C) viruses, HIV (I–V), atypical mycobacteria, and certain systemic fungi – further emphasize the need for aerosol protection. Handle other infectious samples according to good laboratory procedures and methods to prevent spread of disease. Because spills may generate aerosols, observe proper safety precautions for aerosol containment. Do not run toxic, pathogenic, or radioactive materials in this rotor without taking appropriate safety precautions. Biosafe containment should be used when Risk Group II materials (as identified in the World Health Organization *Laboratory Biosafety Manual*) are handled; materials of a higher group require more than one level of protection.

Safety Notice

Safety Information for the JS-5.3 Rotor

Although rotor components and accessories made by other manufacturers may fit in the JS-5.3 rotor, their safety in this rotor cannot be ascertained by Beckman Coulter. Use of other manufacturers' components or accessories in the JS-5.3 rotor may void the rotor warranty and should be prohibited by your laboratory safety officer. Only the components and accessories listed in this publication should be used in this rotor.

Hook all four buckets, loaded or empty, to the rotor for every run. Make sure that filled containers are loaded symmetrically into the rotor and that opposing labware is filled to the same level with liquid of the same density.

The rotor and accessories are not designed for use with materials capable of developing flammable or explosive vapors. Do not centrifuge such materials in nor handle or store them near the ultracentrifuge.

If disassembly reveals evidence of leakage, you should assume that some fluid escaped the rotor. Apply appropriate decontamination procedures to the centrifuge and accessories.

Never exceed the maximum rated speed of the rotor and labware in use. Refer to the section on and derate the run speed as appropriate.

Do not use sharp tools on the rotor that could cause scratches in the rotor surface. Corrosion begins in scratches and may open fissures in the rotor with continued use.

Contents

Safety Notice, iii
Alerts for Warning, Caution, Important, and Note, iii
Safety Information for the JS-5.3 Rotor, iii
JS-5.3 Swinging-Bucket Rotor, 1
Specifications, 1
Description, 2
Preparation and Use, 2
Prerun Safety Checks, 3
Installing the Rotor Yoke, 3
Loading the Buckets, 5
Operation, 10
Removal and Sample Recovery, 10
Labware, 11
Run Speeds, 14
Care and Maintenance, 16
Maintenance, 16
Cleaning, 18
Decontamination, 19
Sterilization and Disinfection, 20
Storage, 20
Returning a Rotor, 21
Supply List, 22
Replacement Rotor Parts, 22
Supplies, 22
Beckman Coulter, Inc. J Series Swinging-Bucket Rotor Warranty

Related Documents

Safety Notice, 1

Alerts for Warning, Caution, Important, and Note, 1

Safety Information for the JS-5.3 Rotor, 1

JS-5.3 Swinging-Bucket Rotor, 1

Specifications, 1

Description, 2

Preparation and Use, 2

Prerun Safety Checks, 3

Installing the Rotor Yoke, 3

Loading the Buckets, 5

Operation, 10

Removal and Sample Recovery, 10

Labware, 11

Run Speeds, 14

Care and Maintenance, 16

Maintenance, 16

Cleaning, 18

Decontamination, 19

Sterilization and Disinfection, 20

Storage, 20

Returning a Rotor, 21

Supply List, 22

Replacement Rotor Parts, 22

Supplies, 22

Beckman Coulter, Inc.

J Series Swinging-Bucket Rotor Warranty

Related Documents

[Safety Notice, iii](#)

[Alerts for Warning, Caution, Important, and Note, iii](#)

Safety Information for the JS-5.3 Rotor, iii

JS-5.3 Swinging-Bucket Rotor, 1

Specifications, 1

Description, 2

Preparation and Use, 2

Prerun Safety Checks, 3

Installing the Rotor Yoke, 3

Loading the Buckets, 5

Operation, 10

Removal and Sample Recovery, 10

Labware, 11

Run Speeds, 14

Care and Maintenance, 16

Maintenance, 16

Cleaning, 18

Decontamination, 19

Sterilization and Disinfection, 20

Storage, 20

Returning a Rotor, 21

Supply List, 22

Replacement Rotor Parts, 22

Supplies, 22

Beckman Coulter, Inc.

J Series Swinging-Bucket Rotor Warranty

Related Documents

Illustrations

- 1 Rotor Drive Pin Location and Orientation, 3
- 2 Symmetrical and Balanced Loading, 6
- 3 Correct and Incorrect Alignment of Microplates in the Bucket, 8
- 4 Tube Height Limits for Certain Tube Positions in Adapter
392071, 8
- 5 Tube Height Limits for Certain Tube Positions in Adapter
392072, 8
- 6 Orientation of Capped Tubes in Corner Positions of Adapter
392074, 9
- 7 Bucket Lubrication Area, 17
- 8 Aeroseal Cover, 19

JS-5.3 Swinging-Bucket Rotor

Specifications

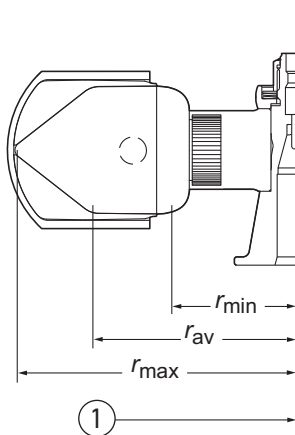
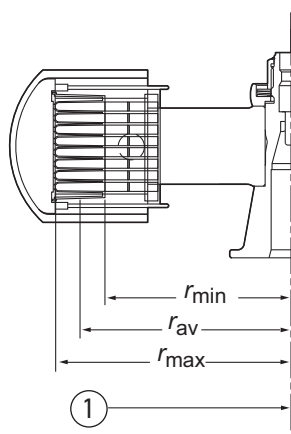

1. Axis of Rotation

Maximum speed	5300 RPM
Critical speed range ^a	500 to 1200 RPM
Density rating at maximum speed	1.2 g/mL
Relative Centrifugal Fields ^b at maximum speed	
<i>Deep-well Plates</i>	
At r_{\max} (194.8 mm)	$6130 \times g$
At r_{av} (179.6 mm)	$5650 \times g$
At r_{\min} (164.3 mm)	$5170 \times g$
<i>500-mL Conical Bottles^c</i>	
At r_{\max} (218.4 mm)	$6870 \times g$
At r_{av} (155.6 mm)	$4900 \times g$
At r_{\min} (92.7 mm)	$2920 \times g$
Conditions requiring speed reductions	see Run Speeds
<i>k</i> factor	
Deep-well plates	1536
500-mL conical bottles	7728
Maximum allowable imbalance of opposing loads	10 grams
Maximum load per bucket	1040 grams
Number of buckets	4
Available labware	see Table 1 and Table 3
Approximate acceleration time to maximum speed (fully loaded)	2 min
Approximate deceleration time from maximum speed (fully loaded)	1 ³ / ₄ min
Weight of fully loaded rotor	14.03 kg (30.91 lb)
Rotor material	aluminum

- The critical speed range is the range of speeds over which the rotor shifts so as to rotate about its center of mass. Passing through the critical speed range is characterized by some vibration.
- Relative Centrifugal Field (RCF) is the ratio of the centrifugal acceleration at a specified radius and speed ($r\omega^2$) to the standard acceleration of gravity (g) according to the following formula: $RCF = r\omega^2/g$ — where r is the radius in millimeters, ω is the angular velocity in radians per second ($2\pi \text{ RPM}/60$), and g is the standard acceleration of gravity (9807 mm/s^2). After substitution: $RCF = 1.12r (\text{RPM}/1000)^2$
- Check manufacturer's specifications for maximum allowed g force of bottles.

Description

Beckman Coulter JS-5.3 rotors are manufactured in a facility that maintains certifications to both ISO 9001:2008 and ISO 13485:2003. They are for use with the specified Beckman Coulter centrifuges.

The JS-5.3 is a four-place swinging-bucket rotor used in Beckman Coulter Avanti JXN-26, J-26S XP series, Avanti J-26 XP series, Avanti J-E, and discontinued J-20 XP series centrifuges. Each rotor bucket can carry a 96-well kit for high-throughput processing (such as a DNA or RNA kit), or standard microplates used in the serial dilution of small liquid volumes—up to six stacked (not to exceed 83.2 mm/3.28 in.) 96-well polypropylene plates, two (stacked) deep-well plates, or one square-well plate per bucket. An array of adapters carry a wide range of tube and bottle sizes (from 1.5 to 500 mL).

The rotor yoke is made of aluminum and is black-anodized for corrosion protection. Blue-anodized aluminum buckets can be run by placing them over pivot pins on the arms of the yoke; they swing out to horizontal position during centrifugation. A tie-down knob secures the rotor to the centrifuge drive hub.

Aeroseal covers, made of transparent polyphenylsulfone (PPSU) are available. These covers have been tested* to demonstrate containment of microbiological aerosols under normal conditions of the associated Beckman Coulter rotors and centrifuges when used and maintained as instructed. In the event of labware leakage, the covers will contain liquids and broken labware, reducing the need to clean the centrifuge chamber and allowing you to take appropriate precautions before removing the covers.

Each cover requires a replaceable silicone rubber O-ring that seats around the outside edge of the cover. An air-vent filter allows passage of air, but not of liquids or aerosols larger than 0.3 micron, in and out of the bucket to minimize the effects of vacuum conditions inside the centrifuge during operation. The covers are held in place by attached latches.

Refer to the Warranty at the back of this manual for warranty information.

Preparation and Use

Specific information about the JS-5.3 rotor is given here. Use the J Series Rotors and Tubes Manual (JR-IM) along with this rotor manual for complete rotor and accessory operation.

NOTE Although rotor components and accessories made by other manufacturers may fit in the JS-5.3 rotor, their safety in this rotor cannot be ascertained by Beckman Coulter. Use of other manufacturers' components or accessories in the JS-5.3 rotor may void the rotor warranty and should be prohibited by your laboratory safety officer. Only the components and accessories listed in this publication should be used in this rotor.

* Validation of microbiological containment was done at an independent third-party testing facility, Health Protection Agency, Porton Down. Improper use or maintenance may affect seal integrity and thus containment.

Prerun Safety Checks

Read the [Safety Notice](#) page at the front of this manual before using the rotor.

- 1 Make sure that the rotor and buckets are clean and show no signs of corrosion or cracking. If any evidence of damage is present, do not centrifuge the rotor.
- 2 Check the chemical compatibilities of all materials used. Refer to *Chemical Resistances* (publication IN-175).
- 3 Verify that the labware being used is listed in [Table 1](#) or [Table 2](#).

Installing the Rotor Yoke

Two metal drive pins inside the rotor drive hole engage with teeth on the centrifuge hub to prevent the rotor from slipping during acceleration and deceleration. The drive pins are positioned parallel to the rotor yoke arm on which **BECKMAN COULTER** is engraved (see [Figure 1](#)). Note the drive pin orientation as you follow the steps below.

Figure 1 Rotor Drive Pin Location and Orientation

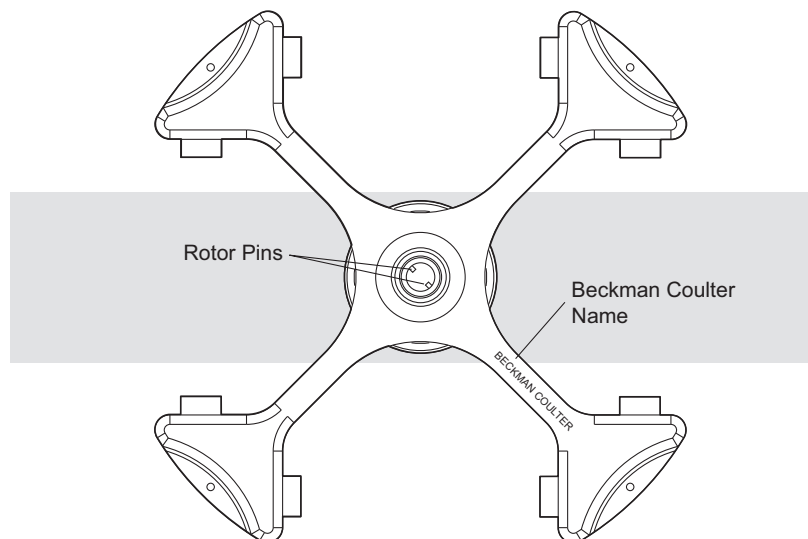

- 1 Rotate the yoke until the pins are either parallel to or perpendicular to the drive spindle hub teeth. The drive pins may rest either next to or between the drive hub teeth.

-
- 2 Carefully lower the rotor straight down onto the centrifuge drive hub.



Carefully lower the rotor yoke straight down onto the drive spindle hub to avoid bending the drive spindle/hub assembly. Do not drop the rotor onto the hub.

-
- 3 Slowly rotate the rotor yoke to make sure it is properly seated.

In rare cases, the rotor pins may rest on top of the hub teeth, preventing the yoke from being secured to the drive hub.

Turning the yoke slightly after installing it will ensure that the rotor is correctly seated.

Lift the rotor yoke slightly while turning it.

-
- 4 Tighten the tie-down knob. The tie-down knob will not engage with the drive hub if the drive pins are on top of the hub teeth.



Securely tighten the tie-down knob to attach the rotor yoke to the centrifuge drive spindle hub. If the rotor is left in the centrifuge between runs, make sure the rotor is seated on the drive hub and the tie-down knob is tight before each run.

NOTE Do not remove the tie-down knob from the rotor.

Loading the Buckets

For runs at other than room temperature, refrigerate or warm the rotor and precool the centrifuge beforehand for fast equilibration.

WARNING

Handle body fluids with care because they can transmit disease. No known test offers complete assurance that such fluids are free of micro-organisms. Some of the most virulent—Hepatitis (B and C) viruses, HIV (I–V), atypical mycobacteria, and certain systemic fungi—further emphasize the need for aerosol protection. Handle other infectious samples according to good laboratory procedures and methods to prevent spread of disease. Because spills may generate aerosols, observe proper safety precautions for aerosol containment.

Do not run toxic, pathogenic, or other hazardous materials in this rotor without taking all appropriate safety precautions. Biosafe containment should be used when Risk Group II materials (as identified in the World Health Organization *Laboratory Biosafety Manual*) are handled; materials of a higher group require more than one level of protection.

Symmetrical and Balanced Loading

To ensure optimal performance and stability, the rotor must be loaded symmetrically (see [Figure 2](#)). Two factors affect symmetric loading:

- The buckets must be loaded symmetrically with respect to their pivotal axes.
- The rotor should be loaded symmetrically with respect to its center of rotation.

For best results, load *opposing* buckets with similar adapter or carrier types and the same type of labware containing the same amounts of fluid of equal density (within 10 grams). To prevent imbalance and reduce centrifuge drive wear, the weight of *adjacent* buckets should be within 220 grams. The maximum load for buckets is 1040 grams each.

During a run, buckets swing 90 degrees from their at-rest position. The pivotal axis of a bucket can be imagined as a line extending across the bucket from one pivot pin to the other. If a bucket is loaded so that its weight is unequally distributed on either side of its pivotal axis, it will not hang vertically at rest and, more importantly, may not swing to a horizontal position during a run. As a result, extra stress will be placed on the bucket, adapter, carrier, tubes, and/or multiwell plates during the run, increasing the possibility of breakage or rotor imbalance.

In multiwell plates, samples should be loaded into the wells symmetrically with respect to the pivotal axis of the carrier (the pivotal axis runs parallel to the crossbar), and opposing buckets should contain similar loads (see [Figure 2](#)).

Figure 2 Symmetrical and Balanced Loading*

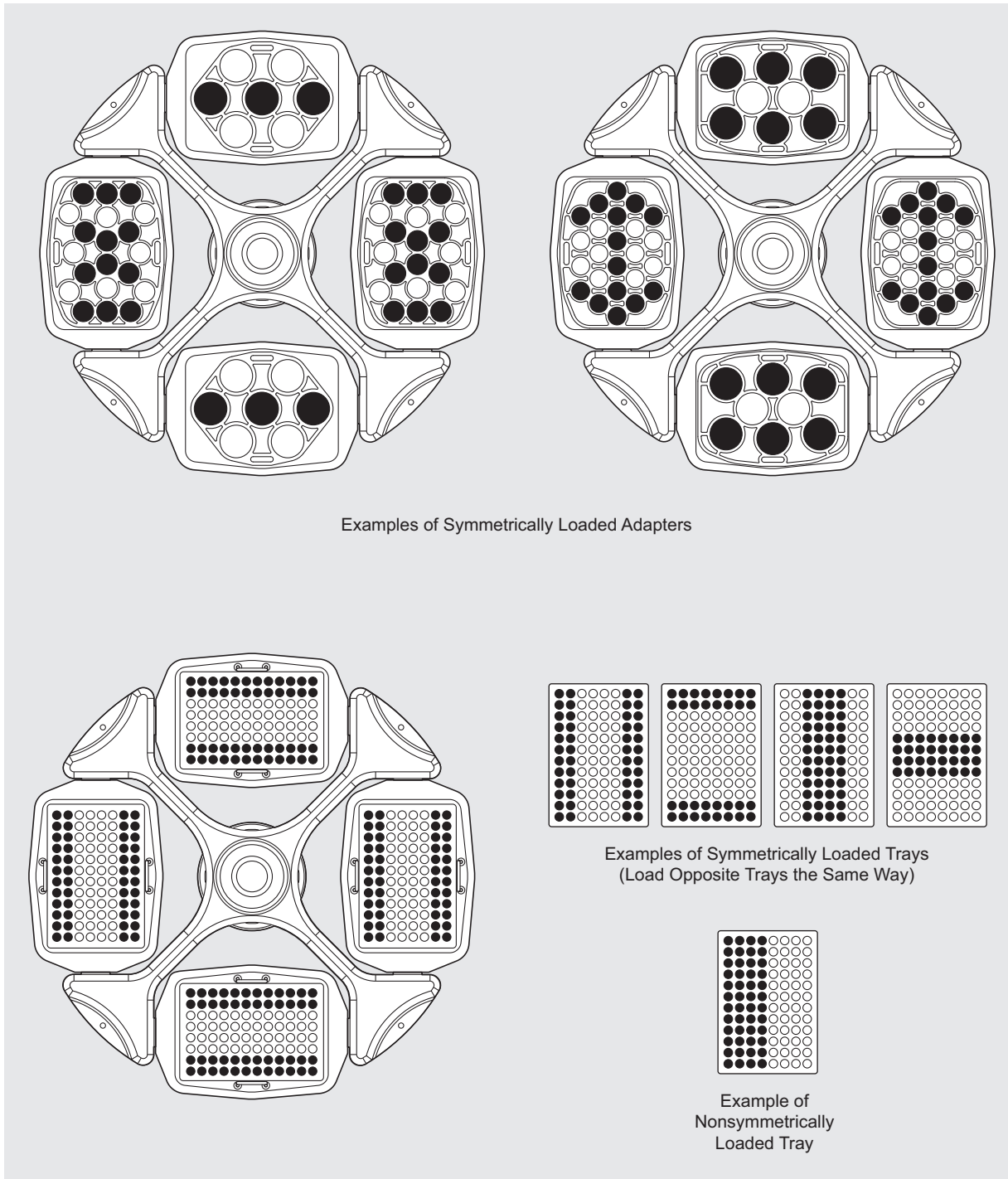

* All four positions must have a bucket attached for every run.

Using Buckets

You can load buckets before or after they are installed on the rotor yoke. In either case, we recommend filling the appropriate labware first and then loading the labware into the buckets to avoid tripping the imbalance detector.

NOTE When using stacked polypropylene microplates, place a support pad (369382) beneath the bottom plate and place a cap strip between plates to prevent breakage during centrifugation. Use the support pad beneath all polystyrene plates.

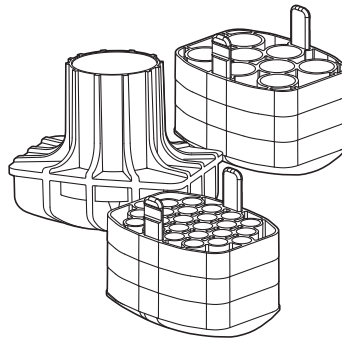

Tube/Bottle Adapters

- 1 Insert the filled labware into the adapter or carrier. (See page 11 for labware information.)

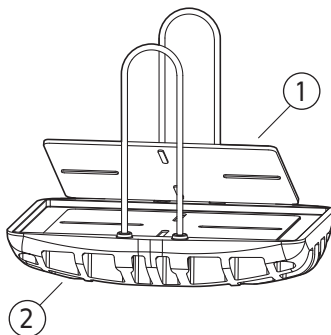

1. Support Pad
2. Microplate Carrier

- 2 Load the filled adapters or carriers into the buckets.
- 3 If using bucket covers, follow the procedure below under [Using Covers](#).
- 4 Attach each bucket to the yoke by aligning the grooves in the bucket sides with the pivot pins, then sliding the buckets down until the pivot pins are seated in the bucket pockets.
- 5 Gently swing the buckets to ensure that they are properly seated on the pivot pins.

Using Covers

NOTE Covers can be used only with blue buckets (368706). They cannot be used with previously manufactured black buckets (368415).

Always visually check to make sure that the labware fits under the cover before your attempt to secure the latches. In addition, note the following information for specific components.

- When using six stacked polystyrene microplates, make sure that the plates are aligned parallel to the bucket edge, as shown in [Figure 3](#), before placing a cover on the bucket.

Figure 3 Correct and Incorrect Alignment of Microplates in the Bucket

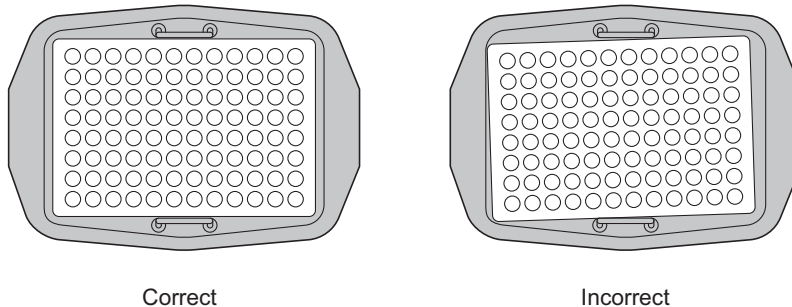

- All adapters listed in [Table 2](#) can be used with covers *except 500-mL conical adapter 392078*.
- Adapters 392071, 392072, and 392074 have the following tube height limits.
 - In adapter 392071, the maximum height of tubes placed in the four corner positions of the adapter (shown shaded in [Figure 4](#)) is 90 mm. Tubes up to 105.4 mm tall can be placed in all other positions.

Figure 4 Tube Height Limits for Certain Tube Positions in Adapter 392071

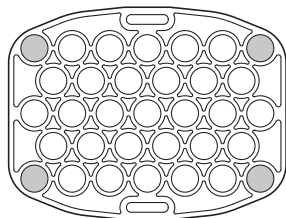

- In adapter 392072, the maximum height of tubes placed in the end positions of the middle row (shown shaded in [Figure 5](#)) is 104 mm. Tubes up to 114 mm tall can be placed in all other positions.

Figure 5 Tube Height Limits for Certain Tube Positions in Adapter 392072

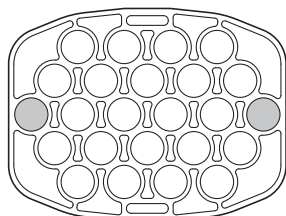

- In adapter 392074, capped tubes placed in the four corner positions must be oriented so that the cap hinges and tabs do not extend towards the corners of the adapter (see Figure 6).

Figure 6 Orientation of Capped Tubes in Corner Positions of Adapter 392074

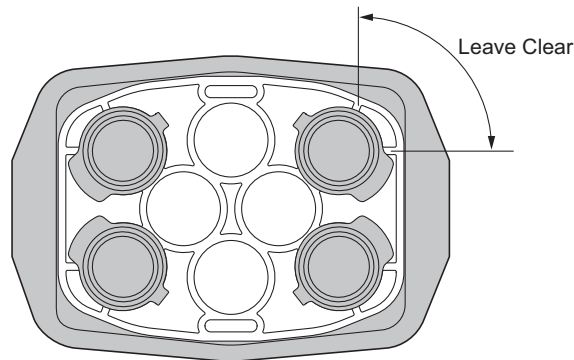

Install the covers as follows.

CAUTION

When centrifuging hazardous materials, load and unload buckets and install and remove Aeroseal covers under an appropriate hood or biological safety cabinet.

- 1 Make sure that the bucket and bucket cover surfaces are clean, dry, and undamaged.
- 2 Make sure that the O-ring (368703) is in good condition and lightly coated with silicone vacuum grease (335148).
- 3 Hold the cover with both hands, holding the latches up, and place the cover on the bucket. Push down on all four corners at once to properly seat the cover. Look at the bucket from the side to make sure that the cover is centered on the bucket.
- 4 Steady the bucket with one hand, and with the other hand, snap one latch down. Then snap the second latch down. *Be careful not to pinch your fingers as you fasten the latches.*
- 5 Look at the bucket/cover interface, checking to make sure that the red O-ring is not protruding at the top of the bucket. If you can see a portion of the O-ring above the bucket top edge, release the latches and remove the cover. Then repeat steps 3 and 4 to reseal the assembly.

Operation

Temperatures may vary slightly between centrifuges. If sample temperature is crucial, test temperature settings on your instrument using water samples. For runs at other than room temperature, refrigerate or warm the rotor beforehand for fast equilibration.

- 1 Refer to the instrument instruction manual for centrifuge operation.
- 2 See *Run Speeds*, for information about speed limitations.

Removal and Sample Recovery



If disassembly reveals evidence of leakage, you should assume that some fluid escaped the rotor. Apply appropriate decontamination procedures to the centrifuge and accessories.

Covers can be removed while the buckets are in the centrifuge, or buckets can be placed on a benchtop before the covers are removed. *If hazardous materials have been centrifuged, place the buckets under an appropriate hood or biological safety cabinet before removing the covers.*

To remove covers while the buckets are in the centrifuge:

- 1 Carefully release the latches, one at a time, keeping the bucket stable with one hand.
Alternately, place your thumb and/or fingers on the edge of the cover and lift up.
A number of different hand positions can be used.
Find one that is comfortable and provides adequate leverage.
See the Note below if you cannot remove a cover.
- 2 Gently lift up one of the latches to break the seal formed during centrifugation.
- 3 Remove the cover, being careful not to disturb the bucket contents.
- 4 Remove the labware from the bucket.

To remove covers from buckets placed on a benchtop:

- 1 Place an absorbent pad on the benchtop to increase bucket stability on the benchtop surface.
- 2 Remove a bucket from the rotor and place the bucket on the pad.
- 3 Carefully release the latches, one at a time.
Lift up on one latch to break the seal.
See the Note below if you cannot remove a cover.
- 4 Remove the cover, being careful not to disturb the bucket contents
- 5 Remove the labware from the buckets.
- 6 If removing the rotor yoke, loosen the tie-down knob and lift the yoke straight up and off the drive hub.

NOTE If a cover is difficult to remove, wait 1 to 2 minutes, then try again to lift the cover off the bucket. If this doesn't work, try changing hand positions and lifting again. If required, use a plastic spatula to lift the cover off the bucket. *Do not* use a metal tool that could damage the O-ring or bucket. To prevent covers from sticking, do the following between runs.

- Lubricate the O-rings with a thin coat of silicone vacuum grease (335148).
- Inspect the air-vent filters before each run to make sure that they are clean. If a filter is discolored, replace it.

Labware

Temperature Limits

- Beckman Coulter plastic adapters and carriers have been centrifuge tested for use at temperatures between 2 and 40°C. For centrifugation at other temperatures, pretest labware under anticipated run conditions.
- If plastic containers are frozen before use, make sure that they are thawed to at least 2°C prior to centrifugation.

Labware

Use the labware listed in [Table 1](#) or [Table 2](#) in the buckets.

NOTE RCF limits in [Table 2](#) are the tested limits for the adapters only. Tubes and bottles used may require lower run speeds. Refer to manufacturers' recommendations and test labware before use.

Table 1 Microplates Used in the JS-5.3 Rotor^a

Description	Volume	Part Number	Accessory Description ^b	Part Number
multiwell polystyrene plate, 96-well, nonsterile	300 µL/well	609844	cap strip, nonsterile ^c	267002 (pkg/12)
			cap strip, sterile ^c	267005 (pkg/12)
			aluminum foil lid ^d	538619 (pkg/100)
deep-well polystyrene plate, 96-well, nonsterile (do not stack these plates)	1 mL/well	267001	cap strip, nonsterile ^c	267002 (pkg/12)
			cap strip, sterile ^c	267005 (pkg/12)
			aluminum foil lid ^d	538619 (pkg/100)
deep-well polystyrene plate, 96-well, sterile (do not stack these plates)	1 mL/well	267004	cap strip, nonsterile ^c	267002 (pkg/12)
			cap strip, sterile ^c	267005 (pkg/12)
			aluminum foil lid ^d	538619 (pkg/100)
deep-well polypropylene plate, 96-well, nonsterile	1 mL/well	267006	cap strip, nonsterile ^c	267002 (pkg/12)
			cap strip, sterile ^c	267005 (pkg/12)
			aluminum foil lid ^d	538619 (pkg/100)
deep-well polypropylene plate, 96-well, sterile	1 mL/well	267007	cap strip, nonsterile ^c	267002 (pkg/102)
			cap strip, sterile ^c	267005 (pkg/12)
			aluminum foil lid ^d	538619 (pkg/100)
square-well polypropylene plate	2 mL/well	140504	aluminum foil lid ^d	538619 (pkg/100)

- High-throughput processing kits are available commercially; observe manufacturer's recommendations for speed and temperature limitations.
- When stacking polypropylene multiwell plates, place a support pad (369382) beneath the bottom plate and a cap strip between the plates to prevent breakage during centrifugation. Also use the support pad beneath all polystyrene deep-well plates.
- Caps are optional.
- Requires 4-inch soft-rubber roller (538618) for installation.

Table 2 Tube and Bottle Adapters for the JS-5.3 Rotor



Adapter	Adapter Color	Part Number (Pkg/4)	Tube/Bottle Size	Maximum Tubes/Bottles per Adapter	RCF at Max Speed (RCF) ^a
	beige	392071 ^b	13 mm dia.	33	6145 × <i>g</i>
	purple	392072 ^b	16 mm dia.	24	6145 × <i>g</i>
	red	392073	17 mm dia.	20	6145 × <i>g</i>
	yellow	392074 ^b	29 mm dia.	8	6145 × <i>g</i>
	green	392075	15 mL conical	18	6425 × <i>g</i> ^c
	black	392076	50 mL conical	7	6480 × <i>g</i> ^c
	orange	392079	250 mL conical	1	6870 × <i>g</i>
	yellow	392077	250 mL round/230 mL conical ^d	1	6670 × <i>g</i>

Table 2 Tube and Bottle Adapters for the JS-5.3 Rotor (Continued)

Adapter	Adapter Color	Part Number (Pkg/4)	Tube/Bottle Size	Maximum Tubes/Bottles per Adapter	RCF at Max Speed (RCF) ^a
	blue	392078 ^e	500 mL conical	1	6870 × g
	yellow	356966 (each)	50 mL conical ^f	1	6670 × g
	yellow	356964 (each)	15 mL conical ^f	4	6670 × g

- Maximum RCF for adapters. Use manufacturers' recommendations for tube and bottle limits.
- Observe limitations described on page 8 when using bucket covers with these adapters.
- Maximum RCF for labware in this adapter is 4000 × g.
- Requires a cushion (356983) to be placed at bottom of adapter.
- Cannot be used with bucket cover.
- Use this adapter inside the 250-mL adapter (392077) to run tubes at 6670 × g.

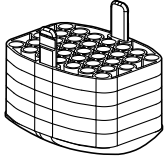
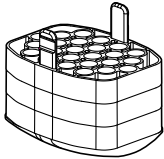
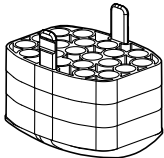
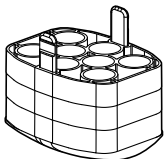
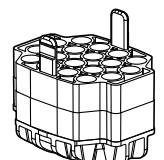
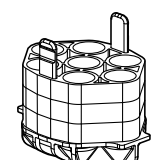
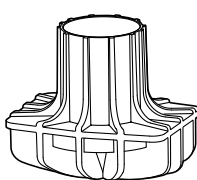
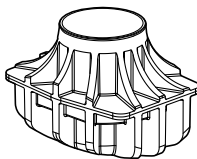
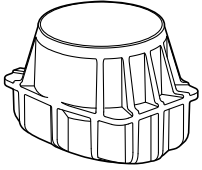
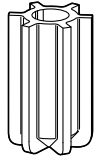
Run Speeds

The centrifugal force at a given radius in a rotor is a function of speed. Comparisons of forces between different rotors are made by comparing the rotors' relative centrifugal fields (RCF). When rotational speed is adjusted so that identical samples are subjected to the same rcf in two different rotors, the samples are subjected to the same force (see [Table 3](#) for examples).

If the weight of the load *in a bucket* exceeds 1040 grams, or if the solution density is more than 1.2 g/mL, reduce the maximum allowable run speed according to the following equation:

$$\text{reduced maximum speed} = (5300 \text{ RPM}) \sqrt{\frac{1040 \text{ grams}}{\text{heaviest load in grams}}}$$

Do not select rotational speeds in excess of 5300 RPM.

NOTE Polystyrene plates are subject to cracking at high speeds. Test polystyrene plates using water in place of sample to determine required speed deration.

Table 3 Relative Centrifugal Fields for the JS-5.3 Rotor^a

Deep-well Plates				500-mL Conical Bottles ^b			
Rotor Speed (RPM)	Relative Centrifugal Field × g			Rotor Speed (RPM)	Relative Centrifugal Field × g		
	At r_{max} (194. mm)	At r_{av} (179.6 mm)	At r_{min} (164.3 mm)		At r_{max} (218.4 mm)	At r_{av} (155.6 mm)	At r_{min} (92.7 mm)
5300	6130	5650	5170	5300	6870	4900	2920
5000	5450	5030	4600	5000	6120	4360	2600
4750	4920	4540	4150	4750	5520	3930	2340
4500	4420	4070	3730	4500	4950	3530	2200
4250	3940	3630	3320	4250	4420	3150	1880
4000	3490	3220	2940	4000	3910	2790	1660
3750	3070	2830	2590	3750	3440	2450	1460
3500	2670	2460	2250	3500	3000	2140	1270
3250	2300	2130	1940	3250	2590	1840	1100
3000	1960	1810	1660	3000	2200	1570	934
2750	1650	1520	1400	2750	1850	1320	785
2500	1360	1260	1150	2500	1530	1090	649
2250	1110	1020	932	2250	1240	882	526
2000	873	805	736	2000	978	697	415
1750	668	616	564	1750	749	534	318
1500	491	453	414	1500	550	392	234
1000	218	201	184	1000	245	174	104
750	115	103	108	750	138	98	58
500	55	50	46	0	0	0	0

- a. Entries in the table are calculated from the formula $RCF = 1.12r (RPM/1000)^2$ and then rounded to three significant digits.
 b. Refer to manufacturers' recommendations for maximum RCF limits of bottles.

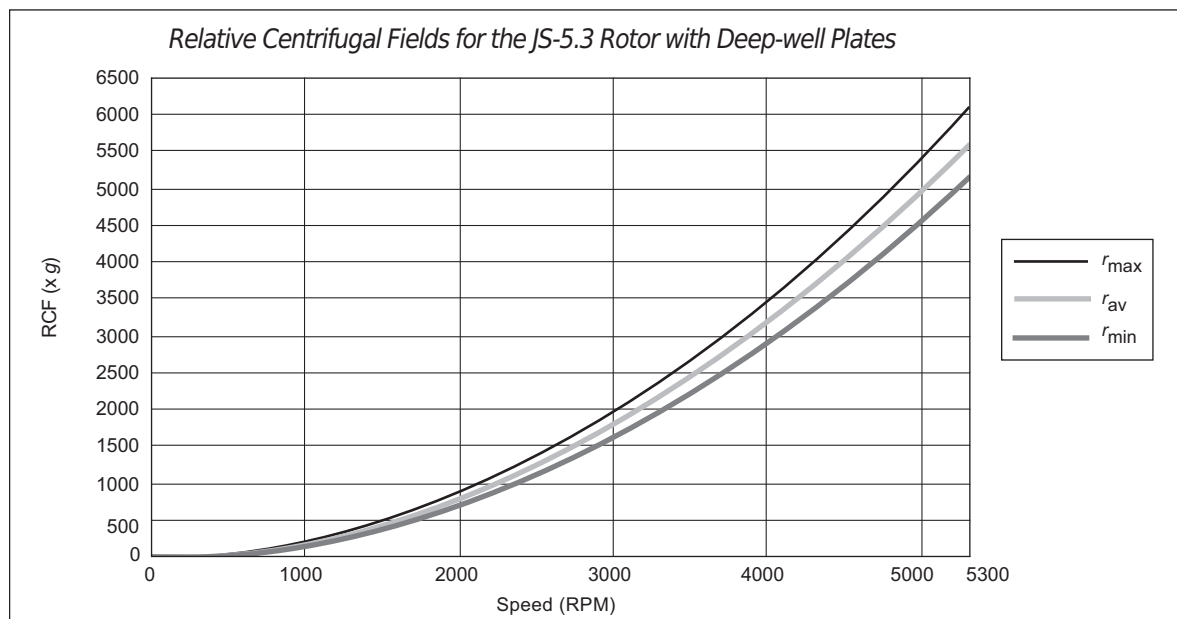

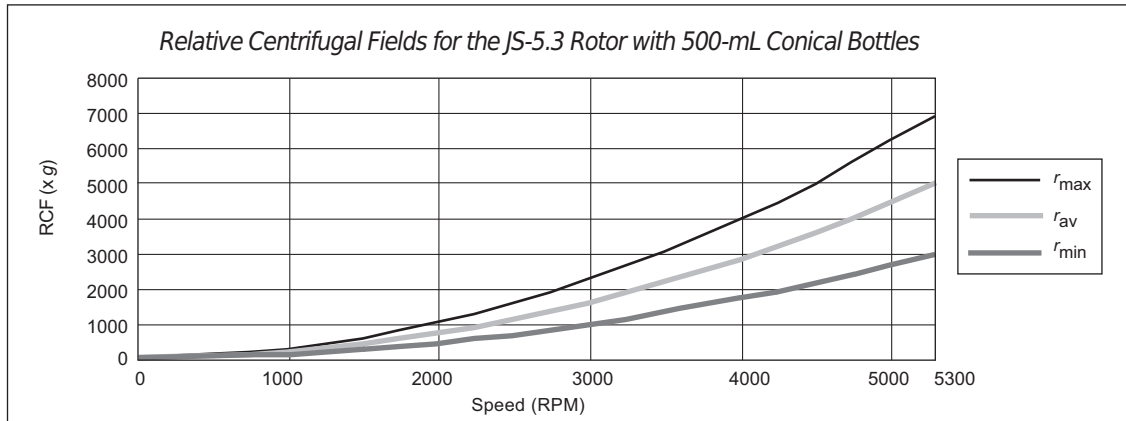

Care and Maintenance

Maintenance

Do not use sharp tools on the rotor that could cause scratches in the rotor surface. Corrosion begins in scratches and may open fissures in the rotor with continued use.

- 1 Periodically (at least monthly) inspect the rotor yoke and buckets, especially inside cavities, for rough spots or pitting, cracks, white powder deposits—frequently aluminum oxide—or heavy discoloration.

If any of these signs are evident, do not run the rotor.

Contact your Beckman Coulter representative for information about the Field Rotor Inspection Program and the rotor repair center.
- 2 Before using the rotor, inspect the rotor drive pins to ensure that they are not damaged.

Damaged drive pins can prevent the rotor from seating properly on the centrifuge drive hub (Avanti J series centrifuges only).

To inspect the drive pins, turn the rotor upside down and look into the drive hole in the center of the rotor.

If the drive pins appear damaged, contact Beckman Coulter Field Service.
- 3 Before using the rotor tie-down knob (368410), check it for damage such as distortion, splitting, or stripped threads.

Replace it if it is damaged.

-
- 4** Before each use, inspect the covers to make sure they are in good condition.
Do not use a cover that is cracked or damaged.
Inspect each O-ring to make sure that is smooth and free of nicks, tears, and abrasions.
Make sure that it has not stretched beyond its original shape and size.
Inspect the top edge of the rotor bucket to make sure that is clean and smooth.

-
- 5** Inspect the bucket cover air-vent filters before each run to make sure that they are clean.
If a filter is discolored, replace it by gently pushing it out from underneath the cover with a pencil or other non-metal tool that will not scratch the cover material.
Insert a new air-vent filter into each cover.
An audible snap will be heard as the filter is inserted.
When properly inserted, the filter will sit slightly (0.76 mm) above the cover surface.

-
- 6** Approximately once a week, and after cleaning and/or autoclaving, wipe the rotor pins and pin sockets (see [Figure 7](#)) with a paper towel, then coat pin sockets with Paint On Graphite Lubricant (977212).
Allow the lubricant to dry for at least 5 minutes before installing the rotor in a centrifuge.

Figure 7 Bucket Lubrication Area

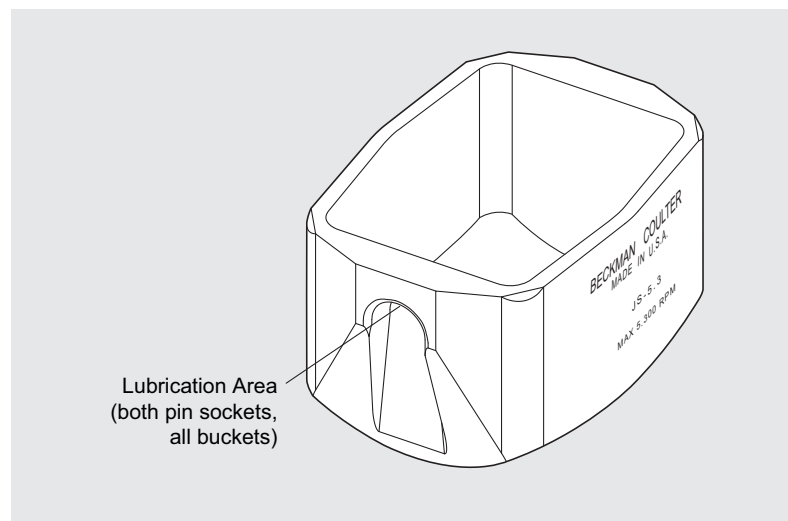

-
- 7** Apply a light film of powder, such as talcum powder, to the tube adapter rubber bases after cleaning or as required to prevent sticking.

-
- 8 Store the rotor in a dry environment (not in the centrifuge).

Refer to *Chemical Resistances* (publication IN-175) for the chemical compatibilities of rotor and accessory materials.

Your Beckman Coulter representative provides contact with the Field Rotor Inspection Program and the rotor repair center.

Cleaning

Wash rotor components immediately if salts or other corrosive materials are used or if spillage has occurred. Do not allow corrosive materials to dry on the rotor.

Under normal use, wash the rotor frequently (at least weekly) to prevent buildup of residues.

NOTE Do not wash the rotor components in a dishwasher. Do not soak the rotor in detergent solution for long periods, such as overnight.



- 1 Wash the rotor yoke, buckets, adapters, and microplate carriers in a mild detergent, such as Solution 555 (339555), that won't damage the rotor.

Dilute the detergent with water (10 parts water to 1 part detergent).

The Rotor Cleaning Kit (339558) contains two plastic-coated brushes and two quarts of Solution 555 for use with rotors and accessories.

- 2 Thoroughly rinse the cleaned rotor components with distilled water.
-

- 3 Air-dry the rotor components upside down.

Do not use acetone to dry the rotor.

- 4 When adapters are dry, apply a light film of powder, such as talcum powder, to the rubber bases to prevent sticking.
-

- 5 When the rotor is dry, lubricate the bucket sockets and pins as described under [Maintenance](#).
-

Cleaning Bucket Covers

The covers and O-rings should be cleaned at least weekly under normal use. *Remove and discard the filter before cleaning. Insert a new filter after cleaning and before the next use.*

- 1 Remove the air-vent filters (as described in [Maintenance](#), above) and O-rings from the covers (see [Figure 8](#)).

Figure 8 Aeroseal Cover

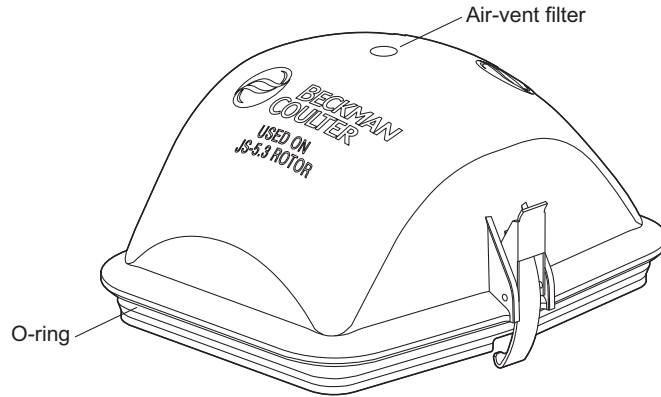

- 2 Wash the covers and O-rings with a mild detergent such as Solution 555 (339555), diluted with water (10 parts water to 1 part detergent).
Do not wash the components in a dishwasher.
- 3 Thoroughly rinse the cleaned components with water and air-dry upside down.
Do not use acetone to dry the components.
- 4 Insert a new air-vent filter into each cover, as described in [Maintenance](#), above.

Decontamination



If aluminum rotor components become contaminated with radioactive material, decontaminate them using a solution that will not damage the anodized surfaces. Beckman Coulter has tested a number of solutions and found two that do not harm anodized aluminum: RadCon Surface Spray or IsoClean Solution (for soaking),* and Radiacwash.†

* In U.S.A., contact Nuclear Associates (New York); in Eastern Europe and Commonwealth States, contact Victoreen GmbH (Munich); in South Pacific, contact Gammasonics Pty, Ltd. (Australia); in Japan, contact Toyo Medic Co. Ltd. (Tokyo).

† In U.S.A., contact Biodex Medical Systems (Shirley, NY); internationally, contact the U.S. office to find the dealer nearest you.

While Beckman Coulter has tested these materials and found that they do not damage components, no guarantee of decontamination is expressed or implied. Follow appropriate decontamination procedures as directed by your laboratory safety officer.

If the rotor or other components are contaminated with toxic or pathogenic materials, follow appropriate decontamination procedures as directed by your laboratory safety officer. Refer to the *Chemical Resistances* (publication IN-175) to ensure that procedures will not damage the components.

Sterilization and Disinfection

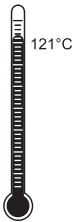

- The rotor can be autoclaved at 121°C for up to an hour. Plastic parts can be autoclaved at 121°C for up to 30 minutes. Place the rotor yoke, buckets, and/or microplate carriers in the autoclave upside down.
- The bucket cover, with air-vent filter removed, can be autoclaved at 121°C for up to 30 minutes. Before autoclaving, remove the filter from each cover as described in [Maintenance](#), above. After autoclaving, insert a new air-vent filter into each cover.
- Ethanol (70%) or hydrogen peroxide (6%) may be used on all rotor components, including those made of plastic. Bleach (sodium hypochlorite) may be used, but may cause discoloration of anodized surfaces. Use the minimum immersion time for each solution, per laboratory standards. Cold sterilization methods such as ethanol (70%), hydrogen peroxide (10%), Wescodyne, or Cidex* may be used on bucket covers. Consult *Chemical Resistances* before using any other sterilization methods.



Ethanol is a flammability hazard. Do not use it in or near operating centrifuges.

using any other sterilization methods.

While Beckman Coulter has tested these methods and found that they do not damage the rotor or components, no guarantee of sterility or disinfection is expressed or implied. When sterilization or disinfection is a concern, consult your laboratory safety officer regarding proper methods to use.

Storage

When it is not in use, store the rotor in a dry environment (not in the centrifuge).

* Cidex is a glutaraldehyde (1,5-pentanedial) product.

Returning a Rotor

Before returning a rotor or accessory for any reason, prior permission must be obtained from Beckman Coulter, Inc. A return form may be obtained from your local Beckman Coulter sales office. The form should contain the following information:

- rotor type and serial number,
- history of use (approximate frequency of use),
- reason for the return,
- original purchase order number, billing number, and shipping number, if possible,
- name and email address of the person to be notified upon receipt of the rotor or accessory at the factory,
- name and email address of the person to be notified about repair costs, etc.

To protect our personnel, it is the customer's responsibility to ensure that all parts are free from pathogens and/or radioactivity. Sterilization and decontamination must be done before returning the parts. Smaller items (such as tubes, bottles, etc.) should be enclosed in a sealed plastic bag.

*All parts must be accompanied by a note, plainly visible on the outside of the box or bag, stating that they are safe to handle and that they are not contaminated with pathogens or radioactivity. **Failure to attach this notification will result in return or disposal of the items without review of the reported problem.***

Use the address label printed on the return form when mailing the rotor and/or accessories.

Customers located outside the United States should contact their local Beckman Coulter office.

Supply List

NOTE Publications referenced in this manual can be obtained at www.beckmancoulter.com, by calling Beckman Coulter at 1-800-742-2345 in the United States, or by contacting your local Beckman Coulter office.

See the Beckman Coulter *High Performance, High Speed, High Capacity Rotors Tubes & Accessories* catalog (BR-8102, available at www.beckmancoulter.com) for detailed information on ordering parts and supplies. For your convenience, a partial list is given below.

Replacement Rotor Parts

Description	Part Number
JS-5.3 rotor assembly	368690
Rotor tie-down knob	368410
Bucket, blue (set of 4)	368706
Containment cover set (includes 2 covers with pre-installed O-rings and air-vent filters, plus 2 each replacement O-rings and filters)	368417
O-ring replacement set (qty/4)	368703
Air-vent filter replacement set (qty/60)	368148
Microplate carrier kit Contains:	368914
Microplate carrier (set of 4)	368905
Support pad (set of 4)	369382

Supplies

NOTE For MSDS information, go to the Beckman Coulter website at www.beckmancoulter.com.

Description	Part Number
Labware	see Table 1 and Table 2
Replacement tube and bottle adapters (set of 2)	
Beige (13 mm dia)	368907
Purple (16 mm dia)	368909
Red (17 mm dia)	368910
Yellow (29 mm dia)	368911
Green (15 mL conical)	368915
Black (50 mL conical)	368916
Orange (250 mL conical)	369385
Yellow (250 mL round/230 mL conical)	369383
Blue (500 mL conical)	369384
Rubber roller, 4-in., for sealing foil microplate lids	538618

Description	Part Number
Rotor Cleaning Kit	339558
Solution 555 (1 qt)	339555
Rotor cleaning brush	339379
Paint On Graphite Lubricant (1/2 oz)	977212
Silicone vacuum grease (1 oz)	335148

JS-5.3 Swinging-Bucket Rotor
Supply List

Beckman Coulter, Inc.

J Series Swinging-Bucket Rotor Warranty

Subject to the conditions specified below and the warranty clause of the Beckman Coulter, Inc., terms and conditions of sale in effect at the time of sale, Beckman Coulter, Inc. agrees to correct either by repair, or, at its election, by replacement, any defects of material or workmanship which develop within seven (7) years after delivery of a J series rotor to the original buyer by Beckman Coulter, Inc. or by an authorized representative, provided that investigation and factory inspection by Beckman Coulter discloses that such defect developed under normal and proper use. Should a Beckman Coulter centrifuge be damaged due to a failure of a rotor covered by this warranty, Beckman Coulter will supply free of charge all centrifuge parts required for repair.

Replacement

Any product claimed to be defective must, if requested by Beckman Coulter be returned to the factory, transportation charges prepaid, and will be returned to Buyer with the transportation charges collect unless the product is found to be defective, in which case Beckman Coulter will pay all transportation charges.

A defective rotor will be replaced by Beckman Coulter at its then current list price less a credit based upon the age of the rotor (years since date of purchase). The Buyer shall not receive credit until the claimed defective rotor is returned to Beckman Coulter's Indianapolis, Indiana facility or delivered to a Beckman Coulter Field Service representative.

The replacement price (cost to Buyer) for the respective rotor shall be calculated as follows:

$$\text{Replacement price} = \text{Current rotor list price} \times \frac{\text{years}}{7}$$

Conditions

1. Except as otherwise specifically provided herein, this warranty covers the rotor only and Beckman Coulter shall not be liable for damage to accessories or ancillary supplies including but not limited to (i) tubes, (ii) tube caps, (iii) tube adapters, or (iv) tube contents.
2. This warranty is void if the rotor has been subjected to customer misuse such as operation or maintenance contrary to the instructions in the Beckman Coulter rotor or centrifuge manual.
3. This warranty is void if the rotor is operated with a rotor drive unit or in a centrifuge unmatched to the rotor characteristics, or is operated in a Beckman Coulter centrifuge that has been improperly disassembled, repaired, or modified.

Disclaimer

IT IS EXPRESSLY AGREED THAT THE ABOVE WARRANTY SHALL BE IN LIEU OF ALL WARRANTIES OF FITNESS AND OF THE WARRANTY OF MERCHANTABILITY AND THAT BECKMAN COULTER, INC. SHALL HAVE NO LIABILITY FOR SPECIAL OR CONSEQUENTIAL DAMAGES OF ANY KIND WHATSOEVER ARISING OUT OF THE MANUFACTURE, USE, SALE, HANDLING, REPAIR, MAINTENANCE, OR REPLACEMENT OF THE PRODUCT.

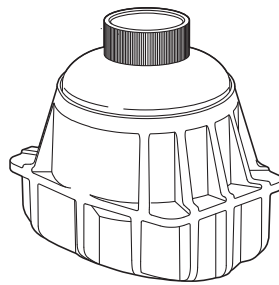
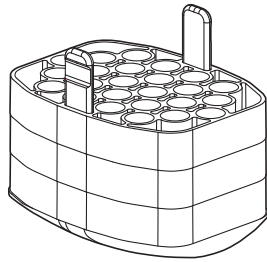
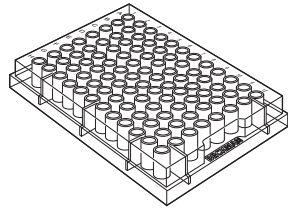

Related Documents

Rotors and Tubes for Beckman Coulter J2, J6, and Avanti J Series Centrifuges

PN JR-IM-10

- Rotors
- Tubes, Bottles, and Accessories
- Using Tubes and Accessories
- Using Fixed-Angle Rotors
- Using Swinging-Bucket Rotors
- Using Vertical-Tube and Rack Type Rotors
- Care and Maintenance
- Chemical Resistances
- Temperature Compensation Tables
- Gradient Materials
- Blood Component Separation

Available in electronic pdf or CD-ROM by request.

Avanti J-26S XP

PN B10087

Avanti J-26S XPI

PN B10093

Avanti J-26 XP

PN J326XP-IM-5

Avanti J-26 XPI

PN J326XPI-IM-4

Avanti J-E

PN SJ-IM-8

Avanti JXN

PN B38322

PN B38323

Chemical Resistances for Beckman Coulter Centrifugation Products

PN IN-175

High Performance, High Speed, High Capacity Rotors, Tubes, & Accessories

PN BR-1802

Available in hard copy by request.

Available at www.beckmancoulter.com

www.beckmancoulter.com

