



Eppendorf ThermoMixer F1.5/FP

Operating manual

eppendorf



Copyright ©2013 Eppendorf AG, Hamburg, Germany. No part of this publication may be reproduced without the prior permission of the copyright owner.

eppendorf, Eppendorf Thermomixer and Eppendorf ThermoTop are registered trademarks of Eppendorf AG, Hamburg, Germany.

condens.protect is a trademark of Eppendorf AG, Hamburg, Germany.

Trademarks are not marked in all cases with TM or [®] in this manual.

Table of contents

1	User instructions	5
1.1	Using this manual	5
1.2	Danger symbols and danger levels	5
1.2.1	Danger symbols	5
1.2.2	Danger levels	5
1.3	Symbols used	6
1.4	Abbreviations used	6
1.5	Glossary	6
2	Product description	7
2.1	Main illustration	7
2.2	Delivery package	8
2.2.1	ThermoMixer F1.5	8
2.2.2	ThermoMixer FP	8
2.3	Features	9
3	Safety	9
3.1	Intended use	9
3.2	User profile	9
3.3	Information on product liability	10
3.4	Warnings for intended use	10
3.5	Warning signs on the device	13
4	Installation	13
4.1	Selecting the location	13
4.2	Installing the instrument	13
5	Operation	14
5.1	Overview of operating controls	14
5.2	Inserting tubes and plates	16
5.3	Installing the ThermoTop	17
5.4	Mixing	18
5.4.1	Mixing without temperature control	18
5.4.2	Mixing and tempering	18
5.4.3	Short Mix	18
5.5	Temperature control	19
5.5.1	Temperature control without mixing process	19
5.6	Menu	20
5.6.1	Navigating in the menu	20
5.6.2	Menu structure	20
5.7	Loading saved parameters	21

6	Troubleshooting	22
6.1	General errors	22
6.2	Error messages	22
7	Maintenance	23
7.1	Cleaning	23
7.2	Disinfection/Decontamination	24
7.3	Decontamination before shipment	24
7.4	Verification of temperature control	24
8	Transport, storage and disposal	25
8.1	Transport	25
8.2	Storage	25
8.3	Disposal	25
9	Technical data	26
9.1	Power supply	26
9.2	Weight/dimensions	26
9.3	Ambient conditions	26
9.4	Application parameters	27
9.4.1	Tempering	27
9.4.2	Mixing	27
9.5	Interface	27
10	Ordering information	28
10.1	Device and accessories	28
10.2	Tubes and plates	28
10.3	Temperature sensor	29
	Index	30

1 User instructions









1.1 Using this manual

- ▶ Read this operating manual completely before using the device for the first time. Please also note the operating instructions for the accessories, if applicable.
- ▶ This operating manual is part of the product. Thus, it must always be easily accessible.
- ▶ Enclose this operating manual when transferring the device to third parties.
- ▶ If this manual is lost, please request another one. For the current version, please refer to our webpage www.eppendorf.com/worldwide (international) or www.eppendorfn.com (North America).

1.2 Danger symbols and danger levels

The safety instructions in this manual appear with the following danger symbols and danger levels:

1.2.1 Danger symbols

	Biohazard		Explosion
	Electric shock		Hot surface
	Hazard point		Risk of fire
	Crushing		Material damage

1.2.2 Danger levels

DANGER	<i>Will</i> lead to severe injuries or death.
WARNING	<i>May</i> lead to severe injuries or death.
CAUTION	<i>May</i> lead to light to moderate injuries.
NOTICE	<i>May</i> lead to material damage.

1.3 Symbols used

Symbol	Meaning
▶	Handling
1. 2.	Actions in the specified order
•	List
<i>Text</i>	Name of fields in the software
i	Useful information

1.4 Abbreviations used

PCR	Polymerase chain reaction
rpm	Revolutions per minute –in rpm

1.5 Glossary

Deepwell plate Plate with 48, 96 or 384 wells with a larger volume than microplates. Suitable for the preparation, mixing, centrifuging, transporting and storing of solid and liquid samples.



Lid Lid for the thermoblock. Ensures uniform temperature control and protects samples from unwanted exposure to light.

Microplate Plate with 24, 48, 96 or 384 wells for the preparation, mixing, centrifuging, transporting and storing of solid and liquid samples.



PCR plate Plate with 96 or 384 wells for PCR applications.

ThermoTop Heated cover for the thermoblock. Prevents the formation of condensation on the inner wall or the lid of the tube thanks to the *condens.protect* technology.

Well Cavity. Microplate, PCR or deepwell plate tube.

2 Product description

2.1 Main illustration

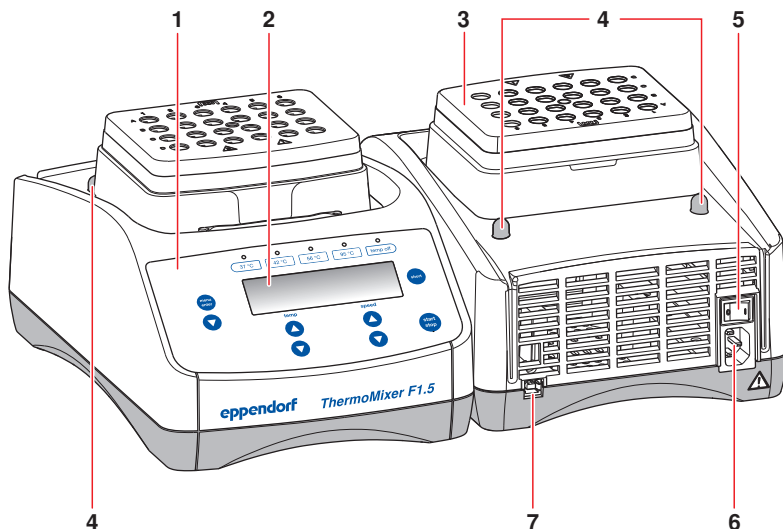

Fig. 1: ThermoMixer F1.5

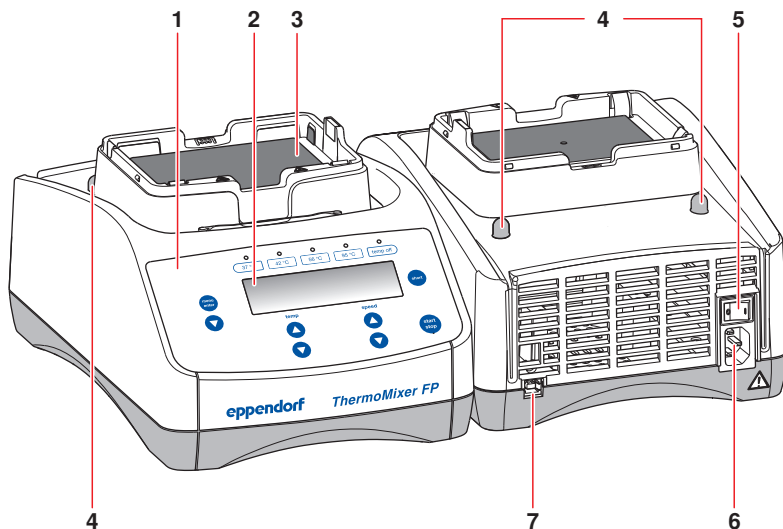

Fig. 2: ThermoMixer FP

1 Operating controls	2 Display
3 Thermoblock	4 Centering pins
5 Power switch	6 Power connection socket
7 USB interface (for Eppendorf Service only)	

2.2 Delivery package

2.2.1 ThermoMixer F1.5

Quantity	Order no. (international)	Order No. (North America)	Description
1	5384 000.012	5384000020	ThermoMixer F1.5 with thermoblock for 1.5 mL tubes
1	–	–	Power supply device
1	5384 900.013		Operating Manual ThermoMixer F1.5/ ThermoMixer FP
1	5384 900.021		Short Instructions ThermoMixer F1.5/ ThermoMixer FP

2.2.2 ThermoMixer FP

Quantity	Order no. (international)	Order No. (North America)	Description
1	5385 000.016	5385000024	ThermoMixer FP with thermoblock
1	–	–	Power supply device
1	5363 000.233	5363000233	Lid for ThermoMixer FP
1	5384 900.013		Operating Manual ThermoMixer F1.5/ ThermoMixer FP
1	5384 900.021		Short Instructions ThermoMixer F1.5/ ThermoMixer FP

- i**
- ▶ Check the delivery for completeness.
 - ▶ Check all parts for damage in transit.
 - ▶ To safely transport and store the device, keep the transport box and packing material.

2.3 Features

With the ThermoMixer F1.5/ThermoMixer FP two basic sample preparation applications can be easily performed in a single step: simultaneous mixing and temperature control of the sample material.

The ThermoMixer F1.5 allows the temperature control and mixing of liquids in 1.5 mL tubes (e.g., Eppendorf Safe-Lock Tubes). The ThermoMixer FP allows the temperature control and mixing of liquids in all common plate formats (e.g., Eppendorf Microplates or Eppendorf Deepwell Plates).

Temperature control

- Temperatures of 4 °C above the ambient temperature to 100 °C are accurately and consistently maintained.
- The temperatures 37 °C, 42 °C, 56 °C, 95 °C can be selected directly.

Mixing

- Anti-spill technology prevents lid wetting and cross contamination.
- ThermoMixer F1.5: You can select mixing frequencies between 300 rpm and 1 500 rpm.
- ThermoMixer FP: You can select mixing frequencies between 300 rpm and 2 000 rpm.
- 2^DMix-Control technology provides for controlled and efficient mixing to ensure rapid and complete mixing of even the smallest volumes.
- **Short Mix:** Short, uncomplicated mixing of sample material. The mixing process runs at the selected speed as long as the **short** key is pressed.

Lid and ThermoTop

- The Lid ensures uniform temperature control and protects samples from unwanted exposure to light.
- The ThermoTop prevents the formation of condensation on the inner wall or the lid of the tube thanks to the *condens.protect* technology.

3 Safety

3.1 Intended use

The ThermoMixer F1.5/ThermoMixer FP is intended for use in a molecular biology laboratory. The ThermoMixer F1.5/ThermoMixer FP is designed for the temperature control and mixing of liquids in closed tubes and closed plates for the preparation and processing of samples.

The ThermoMixer F1.5/ThermoMixer FP is exclusively intended for use indoors. All country-specific safety requirements for operating electrical equipment in the laboratory must be observed.

Only use Eppendorf accessories or accessories recommended by Eppendorf.

3.2 User profile

The device and accessories may only be operated by trained and skilled personnel.

Before using the device, read the operating manual carefully and familiarize yourself with the device's mode of operation.

3.3 Information on product liability

In the following cases, the designated protection of the device may be compromised. Liability for any resulting property damage or personal injury is then transferred to the operator:

- The device is not used in accordance with the operating manual.
- The device is used outside of its intended use.
- The device is used with accessories or consumables which are not recommended by Eppendorf.
- The device is maintained or repaired by people not authorized by Eppendorf.
- The user makes unauthorized changes to the device.

3.4 Warnings for intended use

Read the operating instructions and observe the following general safety information before using the ThermoMixer F1.5/ThermoMixer FP.



DANGER! Risk of explosion.

- ▶ Do not operate the device in areas where work is completed with explosive substances.
- ▶ Do not use this device to process any explosive or highly reactive substances.
- ▶ Do not use this device for processing any substances which could generate an explosive atmosphere.



DANGER! Electric shock as a result of penetration of liquid.

- ▶ Switch off the device and disconnect the power plug before starting cleaning or disinfection work.
- ▶ Do not allow any liquids to penetrate the inside of the housing.
- ▶ Use closed tubes and closed plates.
- ▶ Do not spray clean/spray disinfect the housing.
- ▶ Only plug the device back in if it is completely dry, both inside and outside.



WARNING! Electric shock due to damage to device or mains cable.

- ▶ Only switch on the device if the device and mains cable are undamaged.
- ▶ Only use devices that have been properly installed or repaired.
- ▶ In case of danger, disconnect the device from the mains supply by pulling the power plug from the device or the mains socket or, by using the isolating device intended for this purpose (e.g. emergency stop switch in the laboratory).



WARNING! Lethal voltages inside the device.

- ▶ Ensure that the housing is always closed and undamaged so that no parts inside the device can be contacted by accident.
- ▶ Do not remove the housing of the device.
- ▶ Do not allow any liquids to penetrate the inside of the housing.
- ▶ Do not allow the device to be opened by anyone except service personnel who have been specifically authorized by Eppendorf.



WARNING! Risk from incorrect supply voltage

- ▶ Only connect the device to voltage sources which correspond to the electrical requirements on the name plate.
- ▶ Only use sockets with a protective earth (PE) conductor and suitable power cable.



WARNING! Risk of burns from hot surfaces.

The thermoblock can be very hot after heating and cause burns.

- ▶ Avoid direct contact with a heated thermoblock.



WARNING! Damages to health due to infectious liquids and pathogenic germs.

- ▶ When handling infectious liquids and pathogenic germs, observe the national regulations, the biological security level of your laboratory, the material safety data sheets, and the manufacturer's application notes.
- ▶ Wear personal protective equipment.
- ▶ For comprehensive regulations about handling germs or biological material of the risk group II or higher, please refer to the "Laboratory Biosafety Manual" (source: World Health Organisation, Laboratory Biosafety Manual, in its respectively current valid version).



WARNING! Risk of fire.

- ▶ Do not use this device to process any highly flammable liquids.



WARNING! Damage to health due to contaminated device and accessories.

- ▶ Decontaminate the device and the accessories before storage and shipping.



WARNING! Risk of injury due to incorrect consumables.

- Poorly fitting tubes or plates can become detached from the thermoblock.
- Glass tubes can smash.
- ▶ Only use the thermoblocks with the consumables designed for them.
- ▶ Never use tubes made of glass or other fragile material.



WARNING! Contamination due to opening seals of consumables.

In the following cases, the seals of tubes can spring open. Sample material can escape.

- high vapor pressure of the content
- improperly sealed cover
- damaged sealing lip
- improperly fastened foil
- ▶ Always check that consumables have been sealed tightly before use.

**WARNING! Injury from sample material being thrown out.**

Sample material can be thrown out of open, improperly sealed or unstable tubes and plates.

- ▶ Only mix in closed tubes and closed plates.
- ▶ Observe the nationally prescribed safety environment when working with hazardous, toxic and pathogenic samples. Pay particular attention to personal protective equipment (gloves, clothing, goggles etc.), extraction, and the safety class of the lab.

**CAUTION! Poor safety due to incorrect accessories and spare parts.**

The use of accessories and spare parts other than those recommended by Eppendorf may impair the safety, functioning and precision of the device. Eppendorf cannot be held liable or accept any liability for damage resulting from the use of incorrect or non-recommended accessories and spare parts, or from the improper use of such equipment.

- ▶ Only use accessories and original spare parts recommended by Eppendorf.

**CAUTION! Crush hazard due to moving parts.**

- ▶ Do not replace any consumables during the mixing process.
- ▶ Put on the ThermoTop or Lid prior to the mixing process.
- ▶ Do not remove the ThermoTop or Lid during the mixing process.

**NOTICE! Caution! Strong vibration.**

When mixing at high speeds, items located near the device may be moved by the vibrations of the work surface and, e.g., fall off the work table.

- ▶ Do not place easily movable items near the device or secure them adequately.

**NOTICE! Damage to the display due to mechanical pressure.**

- ▶ Do not apply mechanical pressure to the display.

**NOTICE! Damage to electronic components due to condensation.**



Condensate can form in the device after it has been moved from a cool environment to a warmer environment.

- ▶ After installing the device, wait at least for 3 h. Only then connect the device to the mains.

**NOTICE! Damage from the use of aggressive chemicals.**

- ▶ Do not use any aggressive chemicals on the device or its accessories, such as strong and weak bases, strong acids, acetone, formaldehyde, halogenated hydrocarbons or phenol.
- ▶ If the device has been contaminated by aggressive chemicals, immediately clean it by means of a mild cleaning agent.

3.5 Warning signs on the device

Representation	Meaning	Location
	Risk of burns from hot surfaces.	Upper device side
	▶ Observe the operating manual.	Rear of the device
	Caution! Risk of injury from moving parts. ▶ Observe the operating manual.	On the thermoblock

4 Installation

4.1 Selecting the location

Select the location for the device according to the following criteria:

- Suitable power connection as per the name plate.
- Minimum distance to other devices and walls: 10 cm (3.9 in).
- Bench with a horizontal and even work surface which is designed to support the weight of the device.
- Surrounding area must be well ventilated.
- Location must be protected against direct sunlight.

- i** The mains/power switch and cutting unit of the mains/power line must be easily accessible during operation (e.g. residual current circuit breaker).

4.2 Installing the instrument



WARNING! Risk from incorrect supply voltage

- ▶ Only connect the device to voltage sources which correspond to the electrical requirements on the name plate.
- ▶ Only use sockets with a protective earth (PE) conductor and suitable power cable.

1. Place the ThermoMixer F1.5/ThermoMixer FP onto a suitable work surface.
Position the device in such a way that the ventilation slots on the underside of the device are not obstructed.
2. Connect the power cable to the power connection socket of the device and the power supply.

5 Operation

5.1 Overview of operating controls

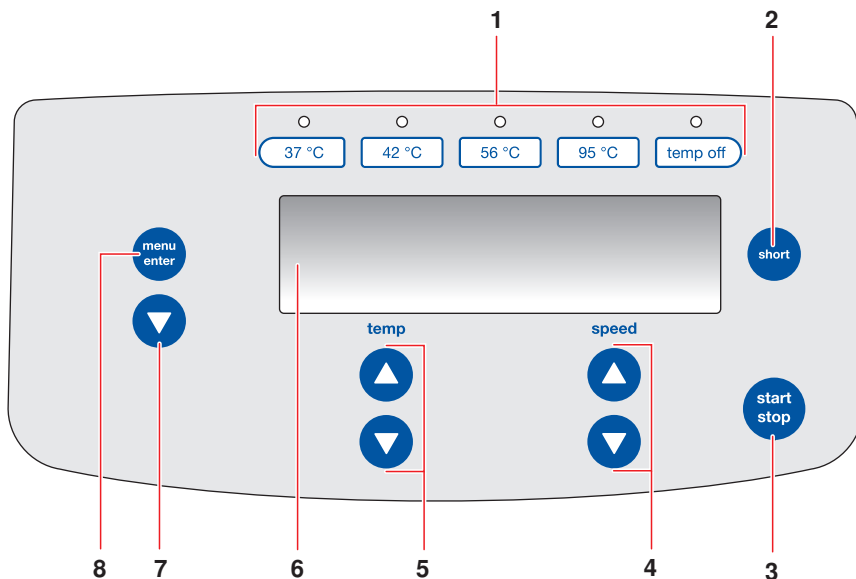

Fig. 3: Operating controls

<p>1 Temperature keys with control LEDs Select a temperature or switch off temperature control</p>	<p>2 short key Short Mix runs as long as the short key is being pressed (see p. 18).</p>
<p>3 start/stop key Start or stop mixing/temperature control</p>	<p>4 Arrow keys speed Set the mixing frequency Keep the arrow key pressed: quick setting</p>
<p>5 Arrow keys temp Set temperature Keep the arrow key pressed: quick setting As soon as the target temperature is modified, the device begins to perform temperature control.</p>	<p>6 Display</p>
<p>7 Menu arrow key Navigate the menu: Set the key lock or the volume</p>	<p>8 menu/enter key Open the menu. Confirm your selection</p>

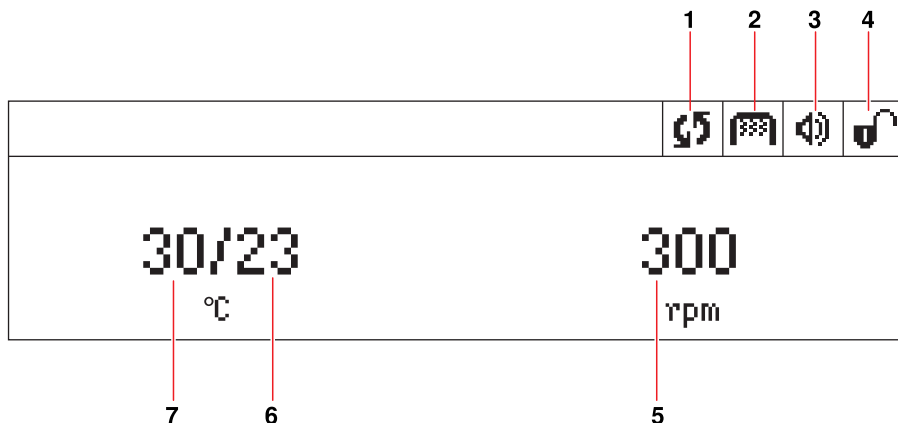







Fig. 4: Display ThermoMixer F1.5/ThermoMixer FP

<p>1 Device status  Device is performing mixing/temperature control.</p>	<p>2 ThermoTop  ThermoTop has been attached. To prevent the formation of condensate, the device heats up the ThermoTop, before the temperature of the thermoblock is controlled.</p>
<p>3 Speaker  Speaker switched on.  Speaker switched off.</p>	<p>4 Key lock  Key lock activated: Parameters cannot be changed.  No key lock.</p>
<p>5 Mixing frequency</p>	<p>6 Actual temperature When the actual temperature flashes on the display, the device is not in temperature control mode operation.</p>
<p>7 Set temperature When the set temperature has been reached, only one value is displayed.</p>	

5.2 Inserting tubes and plates



NOTICE! Damage to plates due to too high temperatures.

Polystyrene microplates melt at temperatures above 70 °C.

Polypropylene deepwell plates deform at temperatures above 80 °C. Deformed plates can become detached from the thermoblock.

- ▶ Only heat microplates up to 70 °C.
- ▶ If you are heating deepwell plates above 80 °C, do not exceed the mixing frequency of 1000 rpm.



NOTICE! Material change of consumables due to extreme temperatures.

Extreme temperatures (e.g., during refrigeration or autoclaving) affect consumables material. The mechanical strength, dimensions and shape of the consumable will change.

- ▶ Use consumables that are suitable for the selected temperature range or selected procedure.



The height sensor of the ThermoMixer FP automatically differentiates between deepwell plates and microplates.

- ▶ When inserting microplates, make sure that the height sensor is not covered.
- ▶ Take care that the height sensor does not get contaminated.

Inserting the plate

- ▶ Insert the plate with the back edge first. Then press it down at the front.

Inserting tubes

- ▶ Insert the tubes completely into the bores of the thermoblock.

Only ThermoMixer FP:

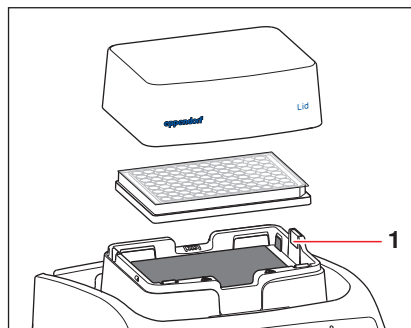

1 Height sensor

- ▶ To ensure uniform temperature control, place the Lid on the thermoblock.

5.3 Installing the ThermoTop

The *condens.protect* technology available with ThermoTop prevents the formation of condensation on the inner wall or the lid of the tube.

Prerequisites

- Tubes or plates have been inserted.

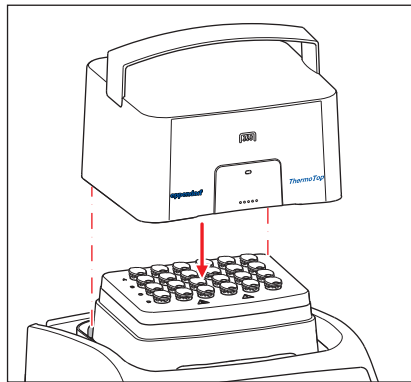

- ▶ Place the ThermoTop on the device vertically from above. The centering pins behind the heating plate fit into the recesses of the ThermoTop.
- The ThermoTop is correctly positioned if the seal is fully flush with the upper part of the device.
- The blue LED of the ThermoTop lights.
- The  symbol appears in the display.

i Functioning principle of the ThermoTop

- In order to prevent the formation of any condensate in a reliable manner, the device first heats the ThermoTop until it reaches the set temperature. The tempering of the thermoblock occurs with a delay.
- The temperature sensor of the thermoblock reacts to the temperature of samples: after inserting samples into a pre-heated thermoblock, the displayed actual temperature may fall temporarily.
- While the device is tempering, the blue LED of the ThermoTop is flashing.

5.4 Mixing

- i** You can select the mixing frequency between 300 rpm and 1 500 rpm (ThermoMixer F1.5) or 2 000 rpm (ThermoMixer FP). The mixing frequency can be adjusted in steps of 50 rpm.

5.4.1 Mixing without temperature control

- In order to switch off the temperature control, press the **temp off** key.



- Set the mixing frequency by means of the **speed** arrow keys.
- In order to start the mixing process, press the **start/stop** key.
 - The **⏻** symbol flashes on the display.
- In order to end the mixing process, press the **start/stop** key.
 - The display shows the last used parameters.

5.4.2 Mixing and tempering

- Set the temperature with the **temp** arrow keys.
The device immediately starts to perform the temperature control.
- Set the mixing frequency with the **speed** arrow keys.

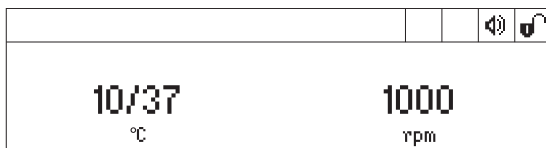

- In order to start the mixing process, press the **start/stop** key.
 - The **⏻** symbol flashes on the display.
 - The display shows the actual temperature/set temperature and the mixing frequency.
- In order to end the mixing process, press the **start/stop** key.
 - The display shows the last used parameters.
 - Temperature control is continued.

5.4.3 Short Mix

Use the Short Mix function for mixing for a short while without temperature control.

- Set the mixing frequency by means of the **speed** arrow keys.
- Keep the **short** key pressed.
The mixing process continues as long as the **short** key will be pressed.
- In order to end Short Mix, release the **short** key.

5.5 Temperature control



NOTICE! Damage to electronic components due to condensation.

Condensate can form in the device after it has been moved from a cool environment to a warmer environment.

- ▶ After installing the device, wait at least for 3 h. Only then connect the device to the mains.

The ThermoMixer F1.5/ThermoMixer FP can be used for temperature control in a range of 4 °C above the ambient temperature to 100 °C.

- When the actual temperature flashes on the display, the device is not in temperature control mode operation.
- As soon as the set temperature is changed with the **temp** arrow keys, the device begins to perform temperature control.
- When the set temperature has been reached, the display only shows one value.

5.5.1 Temperature control without mixing process

1. To switch off the mixing function, use the **speed** arrow keys to select the 0 rpm setting (▼ below 300 rpm or ▲ above 1 500 rpm or 2 000 rpm).

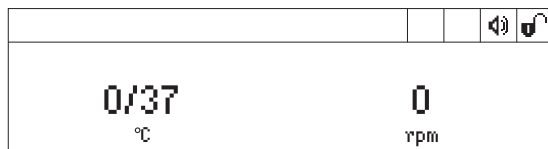





2. Using the **temp** arrow keys set the temperature.
 - The device immediately starts to perform temperature control.
 - When the set temperature is not changed, the actual temperature flashes on the display and the device does not perform temperature control.
3. To manually start the temperature control procedure, press the **start/stop** key.
 - The  symbol flashes on the display.
 - The display shows the actual temperature/set temperature.





5.6 Menu

5.6.1 Navigating in the menu

To change settings, proceed as follows:

1.		To open the menu, press the menu/enter key.
2.		Select the menu item with the menu arrow key.
3.		To confirm your selection, press the menu/enter key.
4.		Change the settings with the menu arrow key.
5.		To confirm the changed setting, press the menu/enter key A tick appears in front of the setting.
6.		To exit the menu level, select the <i>Back</i> menu item and press the menu/enter key.

5.6.2 Menu structure

Menu items and options	Description	Symbol on the display
Key lock <ul style="list-style-type: none"> • <i>Key lock on</i> • <i>Key lock off</i> 	<ul style="list-style-type: none"> • Parameters cannot be changed. • Parameters can be changed. 	 
Volume	<p>The signal tone for error messages is always output at medium volume level regardless of the speaker settings.</p> <ul style="list-style-type: none"> • Set the volume of the speaker: <i>Volume 1, Volume 2, Volume 3</i> • Switching the speaker off: <i>Volume off</i> 	 

Back: Go to next higher menu level.

5.7 Loading saved parameters

The **37 °C** to **95 °C** keys can be used to quickly select a temperature for a temperature control procedure for an unlimited period of time. Use the **temp off** key to switch off temperature control.

	Temperature	Mixing frequency
Key 37 °C	37°C	<i>off</i>
Key 42 °C	42°C	<i>off</i>
Key 56 °C	56°C	<i>off</i>
Key 95 °C	95°C	<i>off</i>
Key temp off	<i>off</i>	<i>off</i>

- ▶ To call a saved temperature, press a direct selection key (**37 °C** to **95 °C**).
 - The LED above the key lights blue.
 - The display shows saved parameters.
- ▶ To start temperature control, press the **start/stop** key.
- ▶ To perform temperature control and mixing at the same time, also set the mixing frequency using the **speed** arrow keys.

i To exit the displayed parameters, set different values for the temperature or mixing frequency.

6 Troubleshooting

If you cannot remedy an error with the recommended measures, please contact your local Eppendorf partner. The contact address can be found online at: www.eppendorf.com/worldwide.

6.1 General errors

Symptom/ message	Cause	Remedy
Display remains dark.	<ul style="list-style-type: none"> No mains connection. 	<ul style="list-style-type: none"> Check the mains connection and the power supply. Switch on device.
Set temperature is not reached.	Set temperature is less than 4 °C above ambient temperature.	<ul style="list-style-type: none"> Set up the device in a cooler environment.
ThermoTop LED does not light.	<ul style="list-style-type: none"> The interface between the device and the ThermoTop is dirty. 	<ul style="list-style-type: none"> Remove any dirt from the front of the ThermoTop. Remove any dirt from the top of the device, especially from the viewing window beside the heating/cooling plate.
ThermoTop does not fit on the device.	The lid is attached to the thermoblock.	<ul style="list-style-type: none"> If using the ThermoTop, do not use the lid.
The device does not mix or control the temperature.	Various causes are possible.	<ul style="list-style-type: none"> Contact your local Eppendorf partner.

6.2 Error messages

Symptom/ message	Cause	Remedy
Error message preceded by a number code.	<ul style="list-style-type: none"> Various causes are possible. 	<ol style="list-style-type: none"> Switch off device and wait 10 seconds. Switch on device. <p>If the error message appears again, contact your local Eppendorf partner.</p>

7 Maintenance

7.1 Cleaning

Clean the housing of the ThermoMixer F1.5/ThermoMixer FP regularly.



DANGER! Electric shock as a result of penetration of liquid.

- ▶ Switch off the device and disconnect the power plug before starting cleaning or disinfection work.
- ▶ Do not allow any liquids to penetrate the inside of the housing.
- ▶ Use closed tubes and closed plates.
- ▶ Do not spray clean/spray disinfect the housing.
- ▶ Only plug the device back in if it is completely dry, both inside and outside.



NOTICE! Damage from the use of aggressive chemicals.

- ▶ Do not use any aggressive chemicals on the device or its accessories, such as strong and weak bases, strong acids, acetone, formaldehyde, halogenated hydrocarbons or phenol.
- ▶ If the device has been contaminated by aggressive chemicals, immediately clean it by means of a mild cleaning agent.



NOTICE! Corrosion from aggressive cleaning agents and disinfectants.

- ▶ Do not use corrosive cleaning agents, aggressive solvents or abrasive polishes.
- ▶ Do not use lab cleaners with sodium hypochlorite.

Auxiliary equipment

- Lint-free cloth
- Mild, soap-based lab cleaner
- Dist. water

Cleaning the ThermoMixer F1.5/ThermoMixer FP

1. Switch off the ThermoMixer F1.5/ThermoMixer FP and disconnect it from the power supply.
2. Clean all of the outer parts of the ThermoMixer F1.5/ThermoMixer FP with a mild soap solution and a lint-free cloth.
3. Wipe off the soap solution with dist. water.
4. Dry all cleaned parts.

7.2 Disinfection/Decontamination

**DANGER! Electric shock as a result of penetration of liquid.**

- ▶ Switch off the device and disconnect the power plug before starting cleaning or disinfection work.
 - ▶ Do not allow any liquids to penetrate the inside of the housing.
 - ▶ Use closed tubes and closed plates.
 - ▶ Do not spray clean/spray disinfect the housing.
 - ▶ Only plug the device back in if it is completely dry, both inside and outside.
-

Auxiliary equipment

- Lint-free cloth
 - Disinfectant.
1. Switch the ThermoMixer F1.5/ThermoMixer FP off and isolate from the power supply.
 2. Allow the device to cool down.
 3. Clean the device (see *Cleaning* on p. 23).
 4. Select a disinfection method which complies with the legal requirements and regulations applicable to your range of application.
 5. Wipe the surfaces with the lint-free cloth and disinfectant.

7.3 Decontamination before shipment

If you are shipping the device to the authorized Technical Service for repairs or to your authorized dealer for disposal please note the following:

**WARNING! Risk to health from contaminated device**

1. Observe the information in the decontamination certificate, You find it as a PDF file on our website (www.eppendorf.com/decontamination).
 2. Decontaminate all the parts you would like to dispatch.
 3. Include the fully completed decontamination certificate in the package.
-

7.4 Verification of temperature control

To verify the temperature accuracy of the thermoblock, use the Eppendorf Temperature Verification System – Single Channel. In combination with the temperature sensor for the ThermoMixer F1.5/ThermoMixer FP the exact temperature in the thermoblock can be measured. Details on the verification process with the Eppendorf Temperature Verification System –Single Channel can be found in the corresponding operating manual.

8 Transport, storage and disposal

8.1 Transport



CAUTION! Bodily injury due to lifting and carrying heavy loads

The device is heavy. Lifting and carrying the device can lead to back injuries.

- ▶ The device must be transported by least two people.
- ▶ Use a transport aid (e.g., dolly) to transport the device longer distances.

- ▶ Use the original packaging for transport.

	Air temperature	Relative humidity	Atmospheric pressure
General transport	-25 °C –60 °C	10 % –75 %	30 kPa –106 kPa
Air freight	-40 °C –55 °C	10 % –75 %	30 kPa –106 kPa

8.2 Storage

	Air temperature	Relative humidity	Atmospheric pressure
In transport packaging	-25 °C – 55 °C	10 % – 95 %	70 kPa – 106 kPa
Without transport packaging	-5 °C – 45 °C	10 % – 95 %	70 kPa – 106 kPa

8.3 Disposal

In case the product is to be disposed of, the relevant legal regulations are to be observed.

Information on the disposal of electrical and electronic devices in the European Community:

Within the European Community, the disposal of electrical devices is regulated by national regulations based on EU Directive 2002/96/EC pertaining to waste electrical and electronic equipment (WEEE).

According to these regulations, any devices supplied after August 13, 2005, in the business-to-business sphere, to which this product is assigned, may no longer be disposed of in municipal or domestic waste. To document this, they have been marked with the following identification:



Because disposal regulations may differ from one country to another within the EU, please contact your supplier if necessary.

9 Technical data**9.1 Power supply**

Power connection	100 V – 130 V \pm 10 %, 50 Hz – 60 Hz 220 V – 240 V \pm 10 %, 50 Hz – 60 Hz
Power consumption	Maximum 200 W
Overvoltage category	II
Degree of pollution	2
Protection class	I

9.2 Weight/dimensions

Dimensions	Width	20.6 cm (8.1 in)
	Depth	30.4 cm (12.0 in)
	Height	ThermoMixer F1.5: 17.0 cm (6.7 in) ThermoMixer FP: 16.4 cm (6.5 in)
Weight	ThermoMixer F1.5: 6.3 kg (13.9 lb) ThermoMixer FP: 6.1 kg (13.4 lb)	

9.3 Ambient conditions

Ambience	Only for use indoors.
Ambient temperature	5 °C – 40 °C
Relative humidity	10 % – 90 %, non-condensing.
Atmospheric pressure	79.5 kPa – 106 kPa

9.4 Application parameters

9.4.1 Tempering

Temperature control range	Minimum: 4 °C above ambient temperature Maximum: 100 °C Temperature setting 1 °C – 100 °C, adjustable in steps of 1 °C	
Temperature accuracy	Set temperature 20 °C – 45 °C	Set temperature < 20 °C or > 45 °C
ThermoMixer F1.5	±0.5 °C	±0.5 °C
ThermoMixer FP	±1.0 °C	±4.0 °C
Temperature homogeneity	In the range of 20 °C – 45 °C max. ±0.5 °C for all positions of the thermoblock	
Heating rate	ThermoMixer F1.5: 11 °C/min ThermoMixer FP: 18 °C/min The change of temperature in filled tubes is slower.	

9.4.2 Mixing

Mixing frequency can be set in increments of 50 rpm	
ThermoMixer F1.5	300 rpm – 1 500 rpm
ThermoMixer FP	300 rpm – 2 000 rpm

9.5 Interface

USB interface	For Eppendorf service only.
---------------	-----------------------------

10 Ordering information

**CAUTION! Poor safety due to incorrect accessories and spare parts.**

The use of accessories and spare parts other than those recommended by Eppendorf may impair the safety, functioning and precision of the device. Eppendorf cannot be held liable or accept any liability for damage resulting from the use of incorrect or non-recommended accessories and spare parts, or from the improper use of such equipment.

- ▶ Only use accessories and original spare parts recommended by Eppendorf.

10.1 Device and accessories

Order no. (international)	Order No. (North America)	Description
5384 000.012 –	– 5384000020	ThermoMixer F1.5 with thermoblock for 1.5 mL tubes 220 V – 240 V 100 V – 130 V
5385 000.016 –	– 5385000024	ThermoMixer FP with thermoblock 220 V – 240 V 100 V – 130 V
5308 000.003	5308000003	ThermoTop with condens.protect technology
5363 000.233	5363000233	Lid for ThermoMixer FP

10.2 Tubes and plates

Order no. (international)	Order No. (North America)	Description
0030 120.086	–	Eppendorf Safe-Lock Tube 1.5 mL 1,000 pieces clear
0030 521.102	951031003	Eppendorf Deepwell Plate 384/200 µL 40 plates, wells clear PCR Clean, white border color
0030 501.101	951031801	Eppendorf Deepwell Plate 96/500 µL 40 plates, wells clear PCR Clean, white border color
0030 501.209	951032603	Eppendorf Deepwell Plate 96/1000 µL 20 plates, wells clear PCR Clean, white border color

Order no. (international)	Order No. (North America)	Description
0030 501.306	951033405	Eppendorf Deepwell Plate 96/2000 µL 20 plates, wells clear PCR Clean, white border color

All plates are available with different border colors (red, yellow, green and blue) and purity qualities, in large packs as well as with barcoding on request. You can find further information in our catalog or on our website www.eppendorf.com.

10.3 Temperature sensor

Order no. (international)	Order No. (North America)	Description
0055 000.298	950008059	Temperature Verification System – Single-channel for Mastercycler, Mastercycler ep, Mastercycler pro and Mastercycler nexus, Thermomixer compact, Thermomixer comfort, Thermostat plus

Index

A	
Actual temperature	15
Application parameters	27
C	
Cleaning	23
condens.protect	17
D	
Decontamination.....	24
Deepwell plate	6, 16
Display	8, 15
Disposal	25
G	
Glossary	6
H	
Hazards	10
Heating rate	27
I	
Installation	
Device	13
Selecting the location	13
Intended use	
Hazards	10
K	
Key lock	
Set	20
Symbol	15
L	
Lid	6, 16
M	
Main illustration.....	7, 7
Menu.....	20
Menu arrow key	14
Navigation	20
Overview	20
Microplate	6, 16
Mixing	18
Application parameters.....	27
Setting the mixing frequency.....	18
stop	14
Symbol.....	15
temperature control run.....	14
without temperature control	18
Mixing frequency	15
Set.....	14
O	
Operating controls.....	8, 14
P	
PCR.....	6
PCR plate	6, 16
Power connection socket.....	8
Power switch	8
R	
rpm	6
S	
Safety precautions.....	10
Select location	13
Set temperature	
Display	15
Short Mix	14
Short Mix	18
Speaker	
Symbol.....	15
Storage.....	25
T	
Technical data	
Ambient conditions.....	26
Application parameters	27
Power supply.....	26
Weights/dimensions.....	26
Temperature	
Set.....	14
Temperature control	19
Temperature key.....	14
Tempering	
Application parameters	27
Switching off the temperature control ..	18
Symbol.....	15
Thermoblock	8

ThermoTop.....6, 17
 Symbol 15
Tubes 16

U

USB interface 8

V

Verification of temperature control 24

Volume

 Set..... 20

W

Warning sign

 Device 13

Well 6

EG-Konformitätserklärung EC Conformity Declaration

Das bezeichnete Produkt entspricht den einschlägigen grundlegenden Anforderungen der aufgeführten EG-Richtlinien und Normen. Bei einer nicht mit uns abgestimmten Änderung des Produktes oder einer nicht bestimmungsgemäßen Anwendung verliert diese Erklärung ihre Gültigkeit.

The product named below fulfils the relevant fundamental requirements of the EC directives and standards listed. In the case of unauthorized modifications to the product or an unintended use this declaration becomes invalid.

Produktbezeichnung, Product name:

ThermoMixer F1.5 / ThermoMixer FP

einschließlich Zubehör / including accessories

Produkttyp, Product type:

Thermomixer für Reaktionsgefäße / Thermomixer for test tubes

Thermomixer für Platten / Thermomixer for plates

Einschlägige EG-Richtlinien/Normen, Relevant EC directives/standards:

2006/95/EG, EN 61010-1, EN 61010-2-010, EN 61010-2-051

2004/108/EG, EN 55011/B, EN 61000-6-1, EN 61000-3-2, EN 61000-3-3, EN 61326-2-6

2011/65/EU

H.-G. Köhler

Vorstand, Board of Management

20.02.2012

Hamburg, Date:

P. Ferri

Projektmanagement, Project Management

eppendorf

Eppendorf AG · Barkhausenweg 1 · 22339 Hamburg · Germany







Evaluate your operating manual

www.eppendorf.com/manualfeedback

eppendorf

Your local distributor: www.eppendorf.com/worldwide

Eppendorf AG · 22331 Hamburg · Germany · Tel: +49 40 53801-0 · Fax: +49 40 538 01-556 · E-mail: eppendorf@eppendorf.com

Eppendorf North America, Inc. · 102 Motor Parkway · Hauppauge, N.Y. 11788-5178 · USA

Tel: +1 516 334 7500 · Toll free phone: +1 800-645-3050 · Fax: +1 516 334 7506 · E-mail: info@eppendorf.com

Application Support Europe: Tel: +49 1803 666 789 (Preis je nach Tarif im Ausland; 9 ct/min aus dem dt. Festnetz; Mobilfunkhöchstpreis 42 ct/min)
support@eppendorf.com

North America: Tel: +1 800 645 3050 · E-mail: techserv@eppendorf.com

Asia Pacific: Tel: +60 3 8023 6869 · E-mail: support_asiapacific@eppendorf.com